



# ASTORE

YOUR PROCUREMENT PARTNER



**This is a strictly confidential support only to be used by Astore clients**



**This catalogue is updated every quarter to provide the latest information**



**For any further information or support please contact your local Astore team**



**All information can be found in the Supplier section on [Astoreprocurement.com](https://www.astoreprocurement.com)**

SUPPLIER DIRECTORY

# Preface



# PORTUGAL NOMINATED SUPPLIERS

## FF&E



ASTORE ENA – NOMINATED SUPPLIERS – PORTUGAL

**ASTORE**



## Furniture & Design

**BEDDING**

**INDOOR, OUTDOOR & OFFICE FURNITURE**

**LIGHTING**

**SOFA BEDS**

**SPA & FITNESS EQUIPMENT**

# List of Nominated Suppliers

PORTUGAL



## BEDDING

# ADOVA

Fabricante de camas (colchões, estrados, sobrecolchões). Colchões Tréca e Simmons, bases de cama, cabeceiras, camas extra... fabricados na nossa unidade de produção em Fougères, França, e entregues em todo o mundo. Os produtos Hotelys proporcionarão aos seus hóspedes noites inesquecíveis.



## Preços e condições

Disponíveis em [astoreprocurement.com](http://astoreprocurement.com)

### RSE

Materiais reciclados ✓

Design ecológico ✓

### Países de fabrico:

França, fornecendo para a Europa e Norte de África (exceto Reino Unido e Itália)

### CONTACTO

#### Apenas França:

Gaetane LE DRU

[gledru@adova-group.com](mailto:gledru@adova-group.com)

+33 6 03 85 95 73

#### Todos os outros países:

Jacqueline BERGER

[jberger@adova-group.com](mailto:jberger@adova-group.com)

+33 6 27 64 04 60

### SERVIÇOS

Transporte ✓

Instalação ✓

Gestão de produtos antigos ✓

### Certificações



EcoVadis



TRECA  
PARIS



Eco, Midscale e Premium\*

\*Exceto Swissôtel

HOTELYS

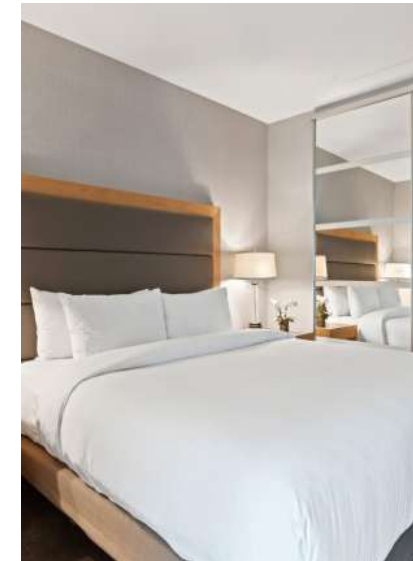

<https://www.hotelys.com/en/>

# ATL PRODUCTION

A ATL é especializada no fabrico de estruturas metálicas e oferece uma gama ampla e diversificada de produtos. A ATL oferece **beliches e mobiliário** para hotéis económicos, **estantes para áreas de serviço** (lavandaria, armazenamento de bagagem, etc.), **Levly**, sistema de elevação de camas



## Preços e condições

Disponível em [astoreprocurement.com](https://astoreprocurement.com)

### CSR

- ✓ Materiais reciclados
- ✓ Programa de segunda vida
- ✓ Eco design

### Serviços

- ✓ Madeira
- ✓ Metal
- ✓ Instalação
- ✓ Feito à medida
- ✓ Quarto
- ✓ Serviços gerais

Instalação interna

**Produção:** 34 Rue Jean Jaurès 23200 Aubusson

**Origem:** EUROPA - FRANÇA

### Certificações



**Pontuação EcoVadis**  
51/100



### Contacto:

Philippe de COURTILLES  
[contact@atlproduction.fr](mailto:contact@atlproduction.fr)  
Tel.: 05 55 66 34 00



Económico

Levly para todas as categorias de hotéis.

## levly®



## RAYONNAGE



## ORÇAMENTO HOSPITALIDADE

Beliches e móveis



# COFEL

O grupo COFEL é hoje líder no setor de roupa de cama na França e parceiro histórico da Accor desde 1988. Somos fornecedores nomeados das seguintes marcas da Accor: 25hours, Adagio, Hotel F1, Grand Mercure, Greet, Handwritten, Ibis, Ibis Styles, Ibis Budget, Jo&Joe, MGallery, Mama Shelter, Mercure, Movenpick, Novotel, Novotel Suites, Pullman, Sofitel, Tribe.

Com a vocação de contribuir para o bem-estar dos consumidores, melhorando a qualidade do seu sono, o Grupo está empenhado e inova constantemente para oferecer o melhor em roupa de cama com as suas 3 marcas muito conhecidas: Bultex, Merinos e Epeda.

 Eco, Midscale e Premium\*

\*Exceto Swissôtel



## Preços e condições

Disponível em [astoreprocurement.com](https://astoreprocurement.com)

### RSE

- ✓ Materiais reciclados
- ✓ Design ecológico

**Países de fabrico:** França, fornecendo a Europa e o Norte de África (excluindo o Reino Unido)

### Certificações



**Pontuação EcoVadis**  
43/100



### Serviços

- ✓ Transporte
- ✓ Instalação
- ✓ Gestão de produtos antigos



### CONTACTO

Para França

Mirko SANTI

[santi.mirko@cofel.biz](mailto:santi.mirko@cofel.biz)

+33969390425

Para todos os outros países:

Élise BAUER

[bauer.elise@cofel.biz](mailto:bauer.elise@cofel.biz)

+33(0)6 40 17 48 99 // +33141902846

 <https://cofel.fr/>

Groupe  
**Cofel**

*Sede:* 57 rue Yves Kermen. BOULOGNE-BILLANCOURT, 92100, França

ASTORE

# FLEX

A Flex é uma marca espanhola icónica, cujo objetivo é melhorar a sua qualidade de vida através do descanso. Somos fornecedores nomeados das seguintes marcas: Ibis, Ibis Styles, Ibis Budget, Greet, Mercure, Novotel, Novotel Suites, Handwritten, Pullman, Movenpick, Grand Mercure, Tribe. País de fabrico: Portugal. Estamos focados na investigação e no design contínuos, os pilares em que nos baseamos para sermos líderes na indústria de roupa de cama.



## Preços e condições

Disponível em [astoreprocurement.com](http://astoreprocurement.com)

### RSE

Materiais reciclados ✓

Concepção ecológica ✓

### Países de fabrico:

Portugal, fornecendo a Europa\* e o Norte de África (exceto Reino Unido e Itália).

### Contacto:

Mario SILVA

[mario.silva@molaflex.com](mailto:mario.silva@molaflex.com)

+351 938 570 456

### SERVIÇOS

Transporte ✓

Instalação ✓

Gestão de produtos antigos ✓

### Certificações

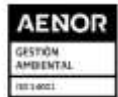

<https://www.flex.es/hoteleria>

 Eco, Midscale e Premium\*

\* Imagens não pertencentes à Accor; consulte os kits de ferramentas para conhecer os padrões da marca.

\*Excluindo Swissôtel

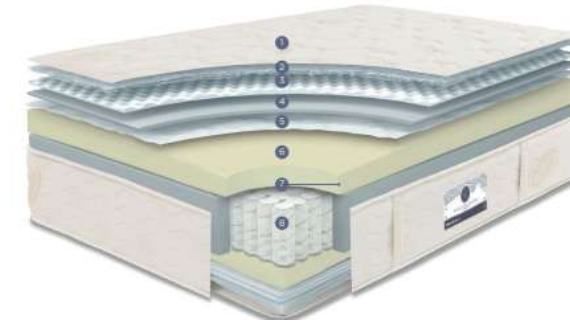

HEIGHT  
34

Metal Noir  
Hauteur: 15cm



# HILDING ANDERS

A Hilding Anders, empresa líder global no setor de roupa de cama e colchões, tem-se empenhado em ajudar as pessoas a terem uma boa noite de sono. Temos orgulho em oferecer soluções de roupa de cama e sono para todas as necessidades e em ter algumas das marcas mais prestigiadas de roupa de cama e colchões no nosso portfólio: Carpe Diem Beds, Jensen, BICO e Slumberland.



## Preços e condições

Disponível em [astoreprocurement.com](https://astoreprocurement.com)

### CSR

Materiais reciclados ✓

Programa Second Life ✓

### Serviços

Transporte ✓

Instalação ✓

Gestão de produtos antigos ✓

**Fábrica:** -Bélgica, Polónia, Espanha, Croácia e Itália

**Fornecimento** Europa e Norte de África

### Certificações



### Pontuação EcoVadis

67/100



### Contacto internacional:

Els Braekman

[els.braekman@hildinganders.com](mailto:els.braekman@hildinganders.com)

+32 9 389 89 49

### Contacto por país

Disponível em [astoreprocurement.com](https://astoreprocurement.com)



<https://www.hildinganders.com/>



Eco, Média gama e Premium

\*Exceto Swissôtel

*Sede: Hilding Anders AB Neptunigatan 1, Posthusplatsen 211 20 Malmö, Suécia*



ASTORE

# TEMPUR SEALY

A Tempur Sealy é líder mundial em design, fabrico, distribuição e venda a retalho de artigos de cama. Somos o fornecedor mundial nomeado para a Swissotel. Além disso, somos fornecedor nomeado no Médio Oriente, África e Pacífico para as seguintes marcas: Mercure, Novotel, Novotel Suites, Handwrite n, Pullman, Movenpick, Grand Mercure, Tribe...



## Preços e condições

Disponível em [astoreprocurement.com](https://astoreprocurement.com)

### CSR

- Materiais reciclados ✓
- Design ecológico ✓

### Serviços

- Transporte ✓
- Instalação ✓
- Gestão de produtos antigos ✓

**Fábrica:** Grécia, Reino Unido, Turquia, Marrocos

**Fornecimento:** Europa, Reino Unido, Turquia e Norte de África

### Certificação



### Pontuação EcoVadis

29/100

### Contacto:

Alexander Gifftthaler

[alexander.gifftthaler@tempursealy.com](mailto:alexander.gifftthaler@tempursealy.com)

+393455818207



<https://www.tempursealy.com/>



Médio e Premium\*

Apenas Swissôtel



TEMPUR+SEALY

*Sede:* Sede global 1000 Tempur Way Lexington, KY 40511

ASTORE

# INDOOR, OUTDOOR & OFFICE FURNITURE





### INDOOR FURNITURE

---

ALMA SANCTURA

APIR

BK ITALIA

COLLINET

DORELAN

FERMOB

MADE IN DESIGN

MAISONS DU MONDE

NAP

PARLA DESIGN

RBC

LIGNE ROSET

RESISTUB

SOCA

TIPTOE BY FERMOB

TISAGE DENANTES

VITRA

WIESNER HAGER

# List of Nominated Suppliers

PORTUGAL

---

A Alma Sanctura é um coletivo especializado em mobiliário contratado, que oferece soluções completas de mobiliário contratado individual e serviços de estofamento para os setores de hotelaria, restauração e promoção residencial. A Alma Sanctura representa um portfólio diversificado de marcas nacionais e internacionais. Como compromisso com a sustentabilidade, o programa ecoSanctura apoia o uso de móveis ecológicos entre os nossos parceiros.

**-25% no folheto**  
**Garantia de 1 a 15 anos contra defeitos de fabrico**

### RSE

Materiais reciclados

Programa Second Life

Concepção ecológica

### Services

personalizado

Modificação dos produtos do catálogo

**Production** : Singapore, Malaysia, Indonesia, China & Belgium

### Contact :

Vanessa LIM  
[sales@almasanctura.com](mailto:sales@almasanctura.com)  
 +65 9625 3744



<https://www.almasanctura.com/>



Range Eco - Mid - Prem - Luxury - Lifestyle



ALMA  
**Sanctura**



# APIR

Apir é especializada no design e fabrico de sinalização e acessórios para hotéis desde 1918: suportes para malas, carrinhos de bagagem, cestos do lixo, cinzeiros, suportes para ementas, porta-guarda-chuvas e muito mais. O seu ponto forte é a produção de sinalização personalizada. Recentemente, adicionaram interruptores e tomadas personalizados à sua gama.



## Gama Eco-Midscale



### CSR

- Materiais reciclados ✓
- Programa Segunda Vida ✗
- Conceção ecológica ✗

### Serviços

- Personalizados ✓
- Modificação de produtos do catálogo ✓

Produção: ITÁLIA  
Origem: ITÁLIA

Pontuação  
EcoVadis 30/100

Serviço de recolha de mobiliário: ✗

 **Contacto:**  
Lauriane COUTURIER  
[laurianec@apir.com](mailto:laurianec@apir.com) Tel:  
+33 (0)6 731178 63

 [Website](#)

O Grupo BK é uma empresa italiana especializada na produção de sofás e poltronas convertíveis há 70 anos. Para mais detalhes sobre produtos específicos, consulte o folheto especializado em camas convertíveis..

**-50%**  
Sobre os preços profissionais da BK

### RSE

Materiais reciclados ✓

Programa Second Life X

Concepción ecológica ✓

### Services

Personalizado ✓

Modificação dos produtos do catálogo ✓

**Production:** ITALIE

**Sourcing :** ITALIE

Recuperación muebles? No

### Certifications

Class IIM materials

### Score EcoVadis

43/100



### Contact :

Sara MANDELLI  
[sara@bkitalia.com](mailto:sara@bkitalia.com)  
 Tel: +39 03 63 48 971  
 Fax: +39 03 63 45 917

### Range Eco-Midscale / Upscale

**BK 132**



**BK 108**



**BK 153**



**BK 116**



For more information on suppliers of sofa beds, please refer to our book specialising in sofa beds and occasional beds.



A Collinet é uma das maiores empresas de mobiliário da França. Desde 1887, a Collinet combina know-how, qualidade e oferece mobiliário com linhas refinadas, que são simultaneamente modernas e tradicionais. .



**-50%**  
Sobre as tarifas profissionais da Collinet

 Midscale to Premium range



### RSE

- Materials reciclados ✓
- Programa Second Life ✓
- Concepción ecológica ✓

**Production** : FRANCE  
**Sourcing** : FRANCE

Recuperación muebles? No

### Services

- Personalizado ✓
- Modificación de productos del catálogo ✓

### Certifications



**EcoVadis Score**  
30/100

### Contact :

Virginie COLLINET  
virginie@collinet-sieges.fr  
Tel: +33 6 85 71 84 84

 [Website](#)

A DORELAN, líder italiana no setor de sofás-cama e camas, foi criada em 1968.

**Preços Accor negociados Enviados mediante solicitação**

Eco-Midscale Range

### RSE

- Materialis reciclados ✗
- Programa Second Life ✓
- Concepción ecológica ✓

### Services

- Personalizado ✓
- Modificación de productos del catálogo ✓

**Production:** ITALY

**Sourcing:** ITALY

**Take-back service**

No

### Certifications



### EcoVadis Score

68/100



[Website](#)



For more information about suppliers of convertible sofa, please refer to our specific book about sofa bed.

**Contact :**

Mirko de Lucia  
m.delucia@dorelan.it  
Tel: +33 7 72 36 58 84

*Headoffice:* Via Due Ponti N 9 47122 Forli Italia  
*Showroom:* 6 Rue De Geneve 69804 - Saint Priest CEDEX FRANCE









**dorelan**  
dormire bene vivere meglio

and a creator of colour in the garden, Fermob has become an expert in the overall design of outdoor spaces through a wide range of furniture, lighting and decorative accessories





**35% off**  
the public prices excluding taxes

### RSE

- Materiais reciclados e recicláveis 
- Segunda vida programa  
- Análise do ciclo de vida 100% 
- Carbon Scan Accor 
- Pintura renovação  
- Retirada de móveis 

### Services

- Feito sob medida 
- Bespoke 



### Certifications

- NF EN 581-1
- NF EN 1022
- NF EN 581-3
- NF EN 581-2

### Score EcoVadis

68/100



 [Fermob-contract.com](https://fermob-contract.com)

**Production :** France   
**Sourcing :** France, Europe, Asie

 **Contact :**

Agnes camacho  
[ACAMACHO@fermob.com](mailto:ACAMACHO@fermob.com)  
Mobile : +33 (0)6 89 01 39 24

*Headoffice: Parc Actival 01140 Thoisy*

*Showroom Professionnels : 79 avenue Ledru Rollin 75012 PARIS  
Neumarkt 49, 50667 Köln, ALLEMAGNE*



Collection VALET BISTRO



Collections MOON! PIAPOLO



Collection FACE A FACE



Collection BELLEVIE



 Gamme Upscale



Collection FUNAMBULE, BE BOP



Collection CALVI, STUDIE, OTO

Como líder europeu no comércio online de mobiliário de design, iluminação e artigos para o lar, a Made In Design tem na sua gama algumas das maiores marcas (Hay, Foscarini, etc.) e designers de renome (Starck, Dixon, etc.).

  
**-20% Sobre os preços públicos\***  
 Made in Design

 Range Premium



**Services**

Feito sob medida

Catálogo de produtos modificados

**Score EcoVadis**

52/100



**Contact**

Charlène LASSALLE  
[classalle@madeindesign.com](mailto:classalle@madeindesign.com)  
 Tel: +33 4 38 12 34 75

X  
✓



**Selection of their manufacturers : HAY | MUUTO | ETHNICRAFT | KARTELL | VITRA | POLS POTTEN | FATBOY | FLOS | ARTEMIDE | ASTRO LIGHTING | SANCAL | & TRADITION | NORMAN COPENHAGEN | GUBI**

Office: 32 rue de Comboire - 38130 ECHIROLLES

\*Prices expressed in EXW

made in design  
 by PRINTEMPS

A Maisons du Monde é uma empresa francesa criada em 1996. É especializada no fabrico e distribuição de mobiliário e decoração para interiores e exteriores. Com a sua equipa integrada de designers, dispõe de uma vasta gama de produtos.



**From -7% to -14%**

Na Maisons du Monde, tarifas públicas para todas as encomendas superiores a 1000 €.

## RSE

Materials reciclados ✓

Programa Segunda Vida ✓

Concepção ecológica ✗

## Services

Feito sob medida ✗

Pequenas modificações nos produtos do catálogo ✗

**Production:** FRANCE, ASIA, EUROPE

**Sourcing :** EUROPE

## Certifications



**Serviço de recolha** No

## EcoVadis Score

68/100



[Website](#)

**Contact :**

Fabienne Sacareau  
fsacareau@maisonsdumonde.com  
Tel: +33 6 08 54 05 52

Eco-Midscale Range



**MAISONS  
DU MONDE**

A NAP é uma empresa polaca fundada em 2005, especializada no fabrico de mobiliário estofado. A empresa também produz mesas, cadeiras e bancos e distribui várias marcas líderes (Ethnicraft, Mullan, Jensen, etc.).

Range Midscale /Premium

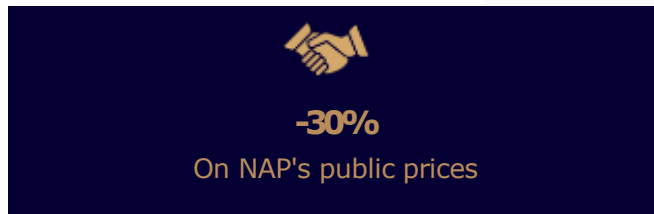

### RCS

Materiais reciclados

✗

Programa Segunda Vida

✓

Concepção ecológica

✗

### Services

Feito sob medida

✓

Modificação dos produtos do catálogo

✓

**Production** : POLAND

**Sourcing** : EUROPE

### Certifications

None

**Serviço de recolha de móveis Não**

**Score EcoVadis**

39/100



### Contact :

Nathalie DEBONO

[Nathalie.debono@nap.com.pl](mailto:Nathalie.debono@nap.com.pl)

Tel: +48 22 699 845 647

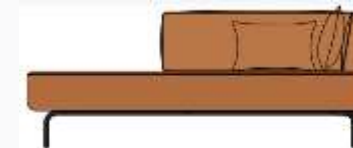

A Parla é especializada no fabrico de mobiliário solto e fixo sofisticado e de alta qualidade + marcenaria para interiores comerciais. A Parla também possui o seu próprio portfólio de produtos concebidos por designers internos e de renome internacional. A Parla Collection está agora a alcançar um crescimento consistente no Reino Unido, Europa, EUA e GCC, com uma excelente rede de revendedores, distribuidores e colaboradores. *network of dealers, distributors and collaborators.*

**-35 % en el folleto**  
**2 años de garantía**

### RSE

- Materials reciclados ✓
- Programa Segunda Vida ✓
- Concepção ecológica ✓

### Services

- Feito sob medida ✓
- Personalização do produto ✓

**Production :** Turkey

**Certifications :**  
ISO 9001, ISO 14001



### Contact :

Neslihan Mingu  
[neslihan.mingu@parladesign.com](mailto:neslihan.mingu@parladesign.com)  
+90 5309612387

<https://parladesign.com/>



Range Eco - Mid - Prem - Luxury - Lifestyle



**Presence on ACCOR concepts**  
Novotel Riyadh Sahafa - Saudi Arabia, Riyadh

**parla\***

Como parceiro privilegiado dos principais grupos hoteleiros, a RBC é capaz de responder a todas as necessidades de FF&E e ajudar na conceção das várias áreas de um hotel, restaurante ou cozinha; desde o átrio até aos quartos, incluindo salões, salas de conferências, salas de jantar ou mesmo áreas de bem-estar ou exteriores, respeitando a arquitetura do local e o projeto imaginado pelo designer ou pelo cliente.

**De 16% a 40%**  
**Nos preços públicos da RBC**

### Services

- Feito sob medida X
- Modificação dos produtos do catálogo X

[Website](#)

**Score EcoVadis**  
65/100



**Contact :**  
Gianluca Tedesco  
gianluca.tedesco@rbcmobilier.com  
+ 33 6 86 13 81 41



Midscale-Premium range

**Selection of their suppliers : ARPER | CASSINA | EMU | GERVASONI | GUBI | INCLASS | KNOLL | ZANOTTA**



Pole Position, um fabricante francês de sofás desde 1991, reflete o artesanato francês. Cada sofá é feito à mão por artesãos qualificados usando métodos de fabricação industrial

**Preços de catálogo -10% para Accor**  
**Preços negociados por projeto**

	Product range
<b>RSE</b>	
Materiais reciclados x	Sofás conversíveis, fixos, com capa removível, ✓
Programa Segunda Vida	modulares, capas separadas disponíveis ✓
Concepção ecológica	
	Customisation available ✓
<b>Production:</b> FRANCE	<b>Certifications:</b>
<b>Sourcing:</b> FRANCE & EUROPE	
<b>Return service:</b>	<b>EcoVadis Score:</b> TBC
Disponível sob consulta	

**Contact:**  
Valentine Thevenin  
Mobile: +33 6 33 31 11 87  
valentine.thevenin@home-and-furniture.netplarme@homespirit.fr



Range Eco - Midscale - Upscale



A company specialized in seats and furniture manufacturing. They can offer customized products. Their factories are specialized in upholstery, foam cutting, leather and fabrics cutting and wood treatment.

**De -35% a -40%**  
**Na ROSET public rates**

Midscale to Upscale range

### RSE

- Materials reciclados
- Programa Segunda Vida
- Conceção ecológica

### Services

- Feito sob medida
- Pequenas modificações nos produtos do catálogo

**Production : FRANCE**

**Sourcing : EUROPE**

### Certifications



**EcoVadis score**

55/100



[Website](#)



**ligne roset®**  
CONTRACTS

**Contact :**

Max Flageollet  
+33 6 80 89 08 09  
[mflageollet@roset.fr](mailto:mflageollet@roset.fr)

*Headoffice & Showroom : BP 9 - 01 470 Briord : 25, rue du Faubourg Saint-Antoine 75 011 Paris*

A RESISTUB PRODUCTIONS é um fabricante francês de mobiliário em metal, madeira e tecido desde 1953. O seu gabinete de design interno pode satisfazer e personalizar todos os pedidos: acabamentos, dimensões e até mesmo acessórios completos.

Range Eco / Midscale

**-20%**  
Sobre preços públicos para encomendas <1000€

**-30%**  
Sobre preços públicos para encomendas >1000€



### RCS

- Materials reciclados ✓
- Programa Segunda Vida ✓
- Concepção ecológica ✓

### Services

- Feito sob medida ✓
- Modificação dos produtos do catálogo ✓

**Production** : FRANCE, POLAND

**Sourcing** : NORTHERN EUROPE

**Serviço de recolha de móveis Não**

### Certifications



### Score EcoVadis

62/100



### Contact :

Amandine GRAVOUIL

Tél : +33 6 50 40 25 99

[Amandine.gravouil@resistub.com](mailto:Amandine.gravouil@resistub.com)

Fundada em 1982, a SOCA fabrica mobiliário contemporâneo e personalizado para o setor hoteleiro. A SOCA tem três especialidades principais: criação de mobiliário personalizado, marroquinaria e estofos.



**-40% Nas tarifas públicas da SOCA**

### RSE

- ✓ Materiais reciclados
- ✓ Programa Second Life
- ✓ Design ecológico

### Services

- ✓ Feito à medida
- ✓ Pequenas alterações nos produtos do catálogo

**Production:** FRANCE

**Sourcing:** FRANCE

**Serviço de recolha Não**

### Contact :

Jacques DE MASCUREAU  
j.de.mascureau@soca.fr  
Tel: +33 2 40 68 85 10

Frédérique Joussemet  
fjoussemet@soca.fr  
Tel: +33 2 40 68 85 10

### Certifications



**EcoVadis Score**  
53/100



Eco - Midscale – Upscale ranges



[Website](#)

# TIPTOE BY FERMOB

TIPTOE é uma marca francesa de design que oferece mobiliário sustentável: bem desenhado, produzido de forma responsável a 100% na Europa e feito para durar



- 25 %

Sobre preços públicos, excluindo o IVA

## RSE

Materiais reciclados ✓

Programa Second-Life ✓

Design ecológico ✓

## Serviços

Feito por Medida ✓

Modificações de luz em produtos de catálogo ✓

**Produção :** FRANÇA

**Fonte :** FRANÇA

**Retoma do serviço?**

Não

## Certificações



## Banda sonora

**EcoVadis:**

60/100



## Contacto:

Agnes Camacho

[acamacho@fermobcontractunit.com](mailto:acamacho@fermobcontractunit.com)

Móvel : +33 (0)6 99 86 99 23



[Local](#)

[Catálogo](#)

[Tarifas públicas](#)

[Livreto de sustentabilidade](#)



Eco Range – Gama Intermédia



✓ Cadeira feita de plástico PP reciclado com base de aço

✓ Empilhável até 8 cadeiras

✓ Tratamento anticorrosivo e resistente aos raios UV



✓ Mesa de aço perfurada com tratamento de cataforese anticorrosiva

✓ Disponível em 2 tamanhos: 160×80 cm e 190×90 cm

✓ Pernas destacáveis

# TIPTOE



# DENANTES

Empresa francesa e familiar há 300 anos.

Especialista em soluções têxteis sob medida para os segmentos hoteleiros: Economy - midscale - luxury.



<https://www.denantes.fr/>



Gamme Eco - Midscale - Upscale



## Collection furniture

Mobiliário de coleção  
Personalizável ou não:  
Assentos  
Sofás  
Mesas  
Cabeceiras  
Mesas de cabeceira  
Secretárias  
Luminárias



## Services

### Quotation

- Descarregamento
- Distribuição
- Desembalagem
- Instalação Estudo de implantação (SketchUp)
- Moodboard



- Remoção e reciclagem dos móveis antigos

## RSE

Madeira proveniente de floresta sustentável

### Programa segunda vida:

- Revestimento
- Reforma de assentos



**Sourcing** : Europe

Sim, sob condições

## Certifications



## Score EcoVadis



## Contact :

Vincent DE FALCO

Tél : 06 85 71 40 55

Mail: [vincent.defalco@denantes.fr](mailto:vincent.defalco@denantes.fr)

*Bureau: adresse des bureaux du fournisseur*

DENANTES  
1723



Fabricante suíço de mobiliário contemporâneo desde 1950, a Vitra produz mobiliário para escritórios, residências e espaços públicos.

**-36% Sobre as tarifas públicas da VITRA**

**RSE**

- Materials reciclados ✓
- Programa Segunda Vida ✓
- Concepção ecológica ✓

**Services**

- Feito sob medida ✗
- Pequenas modificações nos produtos do catálogo ✓

**Certifications**



**Production :** GERMANY  
**Sourcing :** EUROPE

**Serviço de recolha** Não

**EcoVadis score**  
55/100



 [Website](#)



Midscale to Upscale range



**vitra.**

# WIESNER-HAGER



A Wiesner-Hager é um fabricante austríaco de mobiliário fundado em 1921. Oferecemos coleções personalizáveis e de alta qualidade para restaurantes, átrios e áreas de pequeno-almoço. A nossa gama de produtos inclui também mobiliário para espaços de reuniões e eventos, bem como para salas de reuniões. É possível organizar entregas em toda a região EMEA.



**-40% Nas tarifas profissionais da Wiesner-Hager \***

**Services**

- Feito sob medida ✗
- Pequenas modificações nos produtos do catálogo ✓

**Production:** Austria

**Certifications**

**Sourcing:** Austria

 [Website](#)



**Score EcoVadis**

70/100



 **Contact :**

Astid Duberos  
[A.Duberos@wiesner-hager.com](mailto:A.Duberos@wiesner-hager.com)  
 Port 06 17 53 11 29  
 English, German

*Headquarter/Production: Wiesner-Hager, Linzerstraße 22, 4950 Altheim, Austria*

\*EXW prices

# List of Nominated Suppliers

PORTUGAL



## Furniture & Design

### OUTDOOR FURNITURE

AKULA LIVING

ALMA SANCTURA

FERMOB

LIGNE ROSET

MADE IN DESIGN

MAISONS DU MONDE

NAP

PARLA DESIGN

RBC

VITRA

VLAEMYNCK

A Akula é um fabricante global de mobiliário de exterior de qualidade marítima, oferecendo uma vasta gama de produtos em stock e capacidades personalizadas, especificamente concebidos para satisfazer os exigentes requisitos do setor hoteleiro. A Akula possui e opera as suas próprias instalações de fabrico, supervisionando o controlo de qualidade em todas as fases da produção.

**-25%** on the brochure  
**5-year** warranty

## RSE

- Materials reciclados ✓
- Programa Segunda Vida ✓
- Conceção ecológica ✓

**Production :** China, UK, US

## Services

- Feito sob medida ✓
- Personalização do produto ✓

**Certifications :**  
ISO 9001, ISO 14001

## Contact :

Tom DUNNE  
[tom@akulaliving.com](mailto:tom@akulaliving.com)  
+44 1937 862705

<https://akulaliving.com/>

Range Eco - Mid - Prem - Luxury - Lifestyle



## Presence on ACCOR concepts

Fairmont Breakers - Fairmont Cape Grace, South Africa  
Fairmont Century Plaza - Fairmont Dallas - Fairmont Kea Lani

# akula

A Alma Sanctura é um coletivo especializado em mobiliário contratado, que oferece soluções completas de mobiliário contratado individual e serviços de estofamento para os setores de hotelaria, restauração e promoção residencial. A Alma Sanctura representa um portfólio diversificado de marcas nacionais e internacionais. Como compromisso com a sustentabilidade, o programa ecoSanctura apoia o uso de móveis ecológicos entre os nossos parceiros.

**-25% no folheto**  
**Garantia de 1 a 15 anos contra defeitos de fabrico**

## RSE

Materiais reciclados

Programa Second Life

Concepção ecológica

## Services

personalizado

Modificação dos produtos do catálogo

**Production** : Singapore, Malaysia, Indonesia, China & Belgium

## Contact :

Vanessa LIM  
[sales@almasanctura.com](mailto:sales@almasanctura.com)  
 +65 9625 3744



<https://www.almasanctura.com/>



Range Eco - Mid - Prem - Luxury - Lifestyle



ALMA  
**Sanctura**



Como fabricante francês de mobiliário metálico e criador de cores no jardim, a Fermob tornou-se especialista no design integral de espaços exteriores graças à sua vasta gama de mobiliário, iluminação e acessórios decorativos.

  
**35% de desconto sobre preços públicos sem impostos**

- |  |  |                  |   |
|--|--|------------------|---|
| <b>RSE</b>   |  | <b>Serviços</b>  |   |
| ✓ Materiais reciclados e recicláveis   |  | ✓ Feito à medida | ✓ |
| ✓ Programa Second Life  |  | ✓ Personalizado  | ✓ |
| ✓ Análise 100% do Ciclo de Vida  |  |                  |   |
| ✓ Scanner de carbono Accor   |  |                  |   |
| ✓ Pinturarenovação      |  |                  |   |
| ✓ Coleção de móveis  |  |                  |   |



**Certificações**

- NF EN 581-1
- NF EN 1022
- NF EN 581-3
- NF EN 581-2

**Score EcoVadis**

68/100



[Fermob-contract.com](https://www.fermob-contract.com)

**Production :** France   
**Sourcing :** France, Europe, Asie

 **Contato :**

Agnes camacho  
[ACAMACHO@fermob.com](mailto:ACAMACHO@fermob.com)  
 Mobile : +33 (0)6 89 01 39 24



**Collection RESTO, LUXEMBOURG**



**Collection LUXEMBOURG**



**Collection GARDEN OFFICE**



**Collection SWIING**



**Collections BELLEVIE, BEBOP, LORETTE**

*Sede:* Parc Actival 01140 Thoisse  
*Showroom Professionnal:* 79 avenue Ledru Rollin 75012 PARIS  
 Neumarkt 49, 50667 Köln, ALLEMAGNE

# LIGNE ROSET CONTRACT



**-35% a -45%**  
**sobre as tarifas públicas da ROSET**

 Gama Midscale a Upscale

## RSE

Materialis reciclados 

Programa Second Life 

Conceção ecológica 

Production : FRANCE

Sourcing : EUROPE

Serviço de retoma

No

## Serviços

Feito à medida 

Pequenas modificações nos produtos do catálogo 

## Certifications



## EcoVadis score

55/100



[Website](#)



**ligne roset®**  
CONTRACTS

 **Contato :**

Max Flageollet  
+33 6 80 89 08 09  
[mflageollet@roset.fr](mailto:mflageollet@roset.fr)

Como líder europeu no comércio online de mobiliário de design, iluminação e artigos para o lar, a Made In Design tem na sua gama algumas das maiores marcas (Hay, Foscarini, etc.) e designers de renome (Starck, Dixon, etc.).

  
**-20% Sobre os preços públicos\***  
 Made in Design

 Range Premium



**Services**

Feito sob medida

Catálogo de produtos modificados

**Score EcoVadis**

52/100



**Contact**

Charlène LASSALLE  
[classalle@madeindesign.com](mailto:classalle@madeindesign.com)  
 Tel: +33 4 38 12 34 75

X  
✓



**Selection of their manufacturers : HAY | MUUTO | ETHNICRAFT | KARTELL | VITRA | POLS POTTEN | FATBOY | FLOS | ARTEMIDE | ASTRO LIGHTING | SANCAL | & TRADITION | NORMAN COPENHAGEN | GUBI**

Office: 32 rue de Comboire - 38130 ECHIROLLES

\*Prices expressed in EXW

made in design  
 by PRINTEMPS

A Maisons du Monde é uma empresa francesa criada em 1996. É especializada no fabrico e distribuição de mobiliário e decoração para interiores e exteriores. Com a sua equipa integrada de designers, dispõe de uma vasta gama de produtos.

Eco-Midscale Range



**From -7% to -14%**

Na Maisons du Monde, tarifas públicas para todas as encomendas superiores a 1000 €.

### RSE

Materials reciclados ✓

Programa Segunda Vida ✓

Concepção ecológica ✗

### Services

Feito sob medida ✗

Pequenas modificações nos produtos do catálogo ✗

**Production:** FRANCE, ASIA, EUROPE

**Sourcing :** EUROPE

### Certifications



### EcoVadis Score

68/100



[Website](#)

### Contact :

Fabienne Sacareau  
fsacareau@maisonsdumonde.com  
Tel: +33 6 08 54 05 52



A NAP é uma empresa polaca fundada em 2005, especializada no fabrico de mobiliário estofado. A empresa também produz mesas, cadeiras e bancos e distribui várias marcas líderes (Ethnicraft, Mullan, Jensen, etc.).



### RCS

Materialis reciclados ✓

Programa Segunda Vida ✓

Concepção ecológica ✓

### Services

Feito sob medida ✓

Modificação dos produtos do catálogo ✓

**Production** : POLAND

**Sourcing** : EUROPE

### Certifications

None

**Serviço de recolha de móveis Não**

### Score EcoVadis

39/100



### Contact :

Nathalie DEBONO  
[Nathalie.debono@nap.com.pl](mailto:Nathalie.debono@nap.com.pl)  
 Tel: +48 22 699 845 647



Eco- Premium range



A Parla é especializada no fabrico de mobiliário solto e fixo sofisticado e de alta qualidade + marcenaria para interiores comerciais. A Parla também possui o seu próprio portfólio de produtos concebidos por designers internos e de renome internacional. A Parla Collection está agora a alcançar um crescimento consistente no Reino Unido, Europa, EUA e GCC, com uma excelente rede de revendedores, distribuidores e colaboradores. *network of dealers, distributors and collaborators.*

**-35 % en el folleto**  
**2 años de garantía**

### RSE

- ✓ Materiais reciclados
- ✓ Programa Segunda Vida
- ✓ Concepção ecológica

### Services

- ✓ Feito sob medida
- ✓ Personalização do produto

**Production :** Turkey

**Certifications :**  
ISO 9001, ISO 14001



### Contact :

Neslihan Mingu  
[neslihan.mingu@parladesign.com](mailto:neslihan.mingu@parladesign.com)  
+90 5309612387

<https://parladesign.com/>



Range Eco - Mid - Prem - Luxury - Lifestyle



**Presence on ACCOR concepts**  
Novotel Riyadh Sahafa - Saudi Arabia, Riyadh

**parla\***

ASTORE

Como parceiro privilegiado dos principais grupos hoteleiros, a RBC é capaz de responder a todas as necessidades de FF&E e ajudar na conceção das várias áreas de um hotel, restaurante ou cozinha; desde o átrio até aos quartos, incluindo salões, salas de conferências, salas de jantar ou mesmo áreas de bem-estar ou exteriores, respeitando a arquitetura do local e o projeto imaginado pelo designer ou pelo cliente.



**De 16% a 40%**  
**Nos preços públicos da RBC**

**Services**

- Feito sob medida ✗
- Modificação dos produtos do catálogo ✗

 [Website](#)

**Score EcoVadis**  
65/100



**Contact :**  
Gianluca Tedesco  
gianluca.tedesco@rbcmobilier.com  
+ 33 6 86 13 81 41

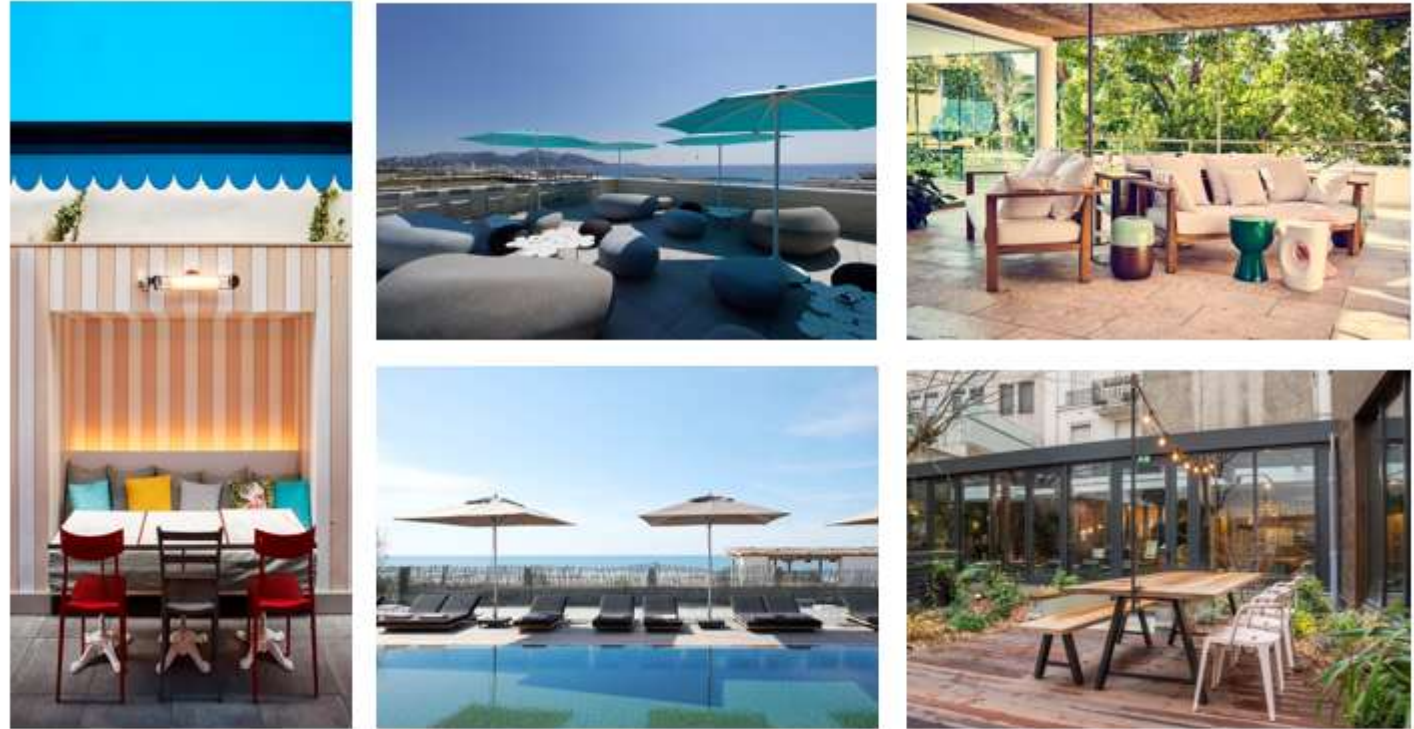

**Selection of their suppliers : ARPER | CASSINA | EMU | GERVASONI | GUBI | INCLASS | KNOLL | ZANOTTA**



Fabricante suíço de mobiliário contemporâneo desde 1950, a Vitra produz mobiliário para escritórios, residências e espaços públicos.

  
**-36% Sobre as tarifas públicas da VITRA**

**RSE**

- Materials reciclados ✓
- Programa Segunda Vida ✓
- Concepção ecológica ✓

**Services**

- Feito sob medida ✗
- Pequenas modificações nos produtos do catálogo ✓

**Certifications**



**Production :** GERMANY  
**Sourcing :** EUROPE

**Serviço de recolha** Não

**EcoVadis score**  
 55/100



 [Website](#)

 **Contact :**

Isabelle DEBUT  
 Isabelle.debut@vitra.com  
 Tel: +33 1 56 77 07 81  
 Mobile : +33 6 61 30 56 40



Midscale to Upscale range



Vlaemy nck is a French company specializing in the production of high-end outdoor furniture and parasols for the hospitality and catering industries. Acquired by Fermob in 2013, it is renowned for the quality, durability, and elegance of its products, designed for hospitality professional. Vlaemy nck offers a diverse range of chairs, tables, sun loungers, cushions, and parasols, primarily manufactured in its workshops in Bourgogne, France.



**40% off**  
the public prices excluding taxes

### RSE

- Materiais reciclados e recicláveis
- Programa de reutilização
- Avaliação do ciclo ue vida
- Carbon Scan Accor
- Furniture take back

### Services

- Sob medida
- Personalizado



### Certifications

- NF EN 581-1
- NF EN 1022
- NF EN 581-3
- NF EN 581-2

### Score EcoVadis

61/100



[Fermob-contract.com](https://www.fermob-contract.com)

**Production :** France

**Sourcing :** France, Europe, Asie



### Contact :

Michael MORRETON  
[MMORRETON@fermobcontractunit.com](mailto:MMORRETON@fermobcontractunit.com)  
Mobile : +49 (0)178 729 3055

*Headoffice: Parc Actival 01140 Thoissey*

*Showroom Professionnels : 79 avenue Ledru Rollin 75012 PARIS  
Neumarkt 49, 50667 Köln, ALLEMAGNE*

### Collections RIVAGE , PILOTIS, KOTO



Collection GORDES



Collection LODGE

Upscale



Collections IBIZA, PARASOLS

**VLAEMY NCK**



## Furniture & Design

### OFFICE FURNITURE

---

LYRECO

VITRA

WIESNER HAGER

# List of Nominated Suppliers

PORTUGAL

---

# LYRECO



Lyreco es una empresa familiar francesa creada en 1926 y presente en 42 países con 12 000 empleados, incluidos 2 000 en Francia. Lyreco cuenta con una fuerza de ventas multispecialista y expertos en mobiliario, higiene, soluciones digitales y seguridad, así como un equipo de 450 repartidores equipados con vehículos diseñados para limitar el impacto ambiental. Lyreco ofrece una gama que cubre todas tus necesidades en tu entorno laboral.



**Negotiated prices for ACCOR**  
Sent on request

 Range Eco - Midscale - Upscale

Break Areas



Relax & Co-Working Areas



Offices



## RSE

- Materials reciclados ✓
- Programa Second Life X
- Concepción ecológica ✓

## Services

- Personalizado X
- Modificação dos produtos do catálogo ✓

**Production :** FRANCE & Europe

**Sourcing :** FRANCE & Europe

**Take-back service?**  
YES

## Certifications



**EcoVadis Score**  
80/100



 [Website](#)

Meeting rooms



Reception areas



Staff lockers



Fabricante suíço de mobiliário contemporâneo desde 1950, a Vitra produz mobiliário para escritórios, residências e espaços públicos.

**-36% Sobre as tarifas públicas da VITRA**

### RSE

- ✓ Materiais reciclados
- ✓ Programa Segunda Vida
- ✓ Conceção ecológica

### Services

- ✗ Feito sob medida
- ✓ Pequenas modificações nos produtos do catálogo

### Certifications



### EcoVadis score

55/100



[Website](#)

**Production :** GERMANY

**Sourcing :** EUROPE

**Serviço de recolha** Não

**Contact :**

Isabelle DEBUT  
 Isabelle.debut@vitra.com  
 Tel: +33 1 56 77 07 81  
 Mobile : +33 6 61 30 56 40



Midscale to Upscale range



# WIESNER-HAGER



A Wiesner-Hager é um fabricante austríaco de mobiliário fundado em 1921. Oferecemos coleções personalizáveis e de alta qualidade para restaurantes, átrios e áreas de pequeno-almoço. A nossa gama de produtos inclui também mobiliário para espaços de reuniões e eventos, bem como para salas de reuniões. É possível organizar entregas em toda a região EMEA.

  
**-40% Nas tarifas profissionais da Wiesner-Hager \***

**Services**

Feito sob medida ✘

Pequenas modificações nos produtos do catálogo ✔

**Production:** Austria

**Sourcing:** Austria

 [Website](#)

**Certifications**



**Score EcoVadis**

70/100



 Midscale / Upscale range



**Contact :**  
 Astid Duberos  
[A.Duberos@wiesner-hager.com](mailto:A.Duberos@wiesner-hager.com)  
 Port 06 17 53 11 29  
 English, German

*Headquarter/Production: Wiesner-Hager, Linzerstraße 22, 4950 Altheim, Austria*

\*EXW prices



# LIGHTING



### LIGHTING

ARTEMIDE

ASTRO LIGHTING

HOEL

BROSSIER SADERNE

RADIAN

ROGER PRADIER

SECURLITE

FERMOB

FARO LOREFAR

FLOS

FRANSEN MADE SPECIFIC

LED C4

MAISON DU MONDE

TARGETTI

# List of Nominated Suppliers

PORTUGAL

# ARTEMIDE

**-40%**  
On Artemide public rates

Midscale / Premium range



### RSE

Recycled materials



Second-Life program



Eco conception



### Services

Personalizado ✓

Modificação dos produtos do catálogo ✓

**Production :** ITALY, FRANCE, HUNGARY

**Sourcing :** EUROPE

### Certifications



**Take-back service**

No

**EcoVadis Score**

TBC



### Contact

Folrian Genevois  
Tel: + 33 06 83 78 77 74  
genevois@artemide.fr



[Website](#)

Showroom: worldwide: Paris, Frankfort, Chicago, L.A., Miami & New York...

Criada em 1997 na Inglaterra, a Astrolighting tornou-se uma referência no mundo do design e da iluminação criativa. Presente em mais de 90 países, a Astrolighting oferece designs inovadores através da sua equipe interna de engenharia.

Midscale / Premium range

45% sobre as tarifas públicas da Astrolighting

### RSE

- Recycled materials ✗
- Second-Life program ✓
- Eco conception ✓

### Product range

- Decorative products (wall lamps, floor lamps, suspensions...) ✓
- Architectural products (spots) ✓
- Custom-Made products ✗

**Production :** EUROPE - CHINA

**Sourcing :** EUROPE - ASIA

### Certifications

N/A

### Take-back service

No

### EcoVadis Score

65/100



### Contact :

Tony THOMPSON  
+44 (0) 1279 427 001  
[athompson@astrolighting.com](mailto:athompson@astrolighting.com)

[Website](http://www.astrolighting.com)



É o catalisador e desenvolvedor de marca da Rivalen, um coletivo de indústrias francesas criado em 2017 para valorizar o saber-fazer das mulheres, que concebem e fabricam soluções de iluminação que combinam funcionalidade, sustentabilidade e respeito pelos materiais. A Rivalen é uma empresa com missão desde abril de 2022. Como especialistas no design e fabricação de luminárias, oferecemos aconselhamento personalizado e trabalhamos consigo para desenvolver as soluções de iluminação ideais para todo o seu estabelecimento. Tudo com Hoël.

## Hoël's brands

### CSR

#### Missão

Trajetória de carbono  
Economia circular

#### rEcodesign

#### Materiais reciclados

Programa de segunda vida

### Services

Gama completa de luminárias  
Sob medida

Modificação de produtos do catálogo



1910  
Creation date

Light fixtures  
Decorative  
outdoor

RADIAN

1985  
Creation date

Lighting for  
workspaces and co-  
working spaces



1986  
Creation date

Light fixtures  
Functional  
and technical



1987  
Creation date

Decorative Lighting  
indoor

Showroom by appointment at 12 rue Lamartine - Paris 09

**Production :** France  
**Sourcing :** France and Europe



### Business contacts

France, Spain, Portugal

Stéphane Aubry

+33 6 85 56 39 50

stephane.aubry@brossier-saderne.com

## Applications

1. Roof-tops, terrasses extérieures
2. Couloirs, cages d'escaliers
3. Chambres, Appartements, Suites
4. Salles de bains, Sanitaires
5. Espaces Bien-Être, Spas, Salles de sport
6. Restaurants, Bars
7. Cuisines, entrepôts, locaux techniques
8. Bureaux, Salles de conférences
9. Réceptions, Lobbies
10. Boutiques intérieures
11. Parking intérieurs & extérieurs
12. Escaliers extérieurs
13. Eclairage extérieur parcs et jardins, piscines

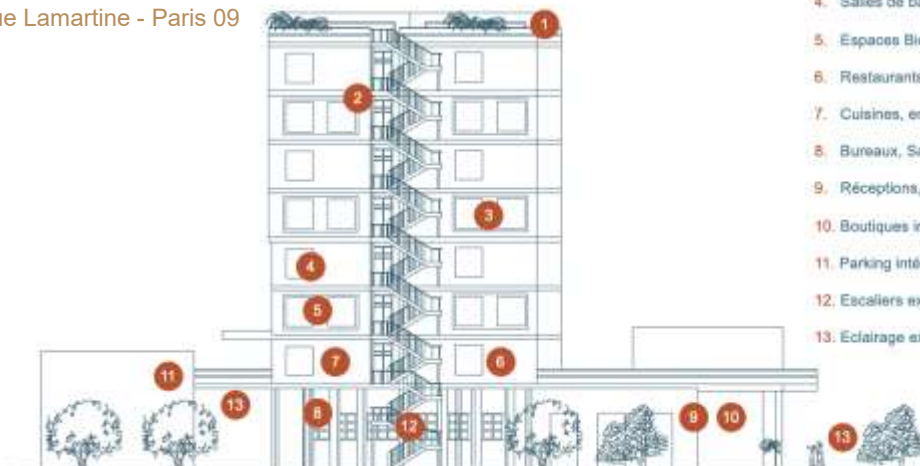

www.hoel.team



COVERED COUNTRIES: ALL EUROPE & NORTH AFRICA

A Brossier Saderne fabrica luminárias para interiores em seus ateliers em Angers, França, desde 1987. A marca beneficia-se de um know-how excepcional, reforçado por um escritório de design interno e uma rede global de mais de 400 parceiros locais, oferecendo acesso a uma ampla gama de materiais e técnicas de fabricação. Como empresa líder no setor hoteleiro, com uma longa história, a Brossier Saderne é reconhecida pela sua capacidade de oferecer soluções de iluminação sob medida



40% de desconto sobre os preços públicos da Brossier Saderne



Eco-Midscale to Premium range

## CSR

- Trajetória 2030, redução das emissões de carbono
- Diagnóstico de resíduos com plano de redução
- Desenvolvimento de metodologia de ecodesign
- Implementação de uma abordagem de compras responsáveis
- Reparabilidade
- Economia circular

## SERVICES

- Iluminação sob medida: projetamos e fabricamos as suas luminárias em todos os tipos de materiais e acabamentos.
- As luminárias do nosso catálogo podem ser personalizadas para se adaptar ao seu mundo
- substituição de lâmpadas

## APPLICATIONS

- Quartos
- Banheiros
- Restaurantes, Bares
- Área de recepção, Lobby...
- Escadas, Corredores
- Bem-estar, Spas
- Áreas de cozinha, Salas de estar (Suítes, Apartamentos de hotel...)
- Escritórios
- Salas técnicas
- Boutiques



Sales contacts

France, Spain, Portugal



[www.brossier-saderne.com](http://www.brossier-saderne.com)

Stephane Aubry

+33 6 13 01 79 11

Showroom by appointment: 12 rue Lamartine - Paris 09

[stephane,aubry@brossier-saderne.com](mailto:stephane,aubry@brossier-saderne.com)

Production Angers, France

Sourcing National with over 400 local partners, Europe

Certification



EcoVadis score Silver 76/100

A Radian é um designer, desenvolvedor e fabricante francês de soluções de iluminação para escritórios. Toda a nossa oferta é produzida na região de Nantes; a empresa é um parceiro local, flexível e ágil. A Radian é especialista em ergonomia visual para o ambiente de trabalho, oferecendo luminárias de chão e produtos para teto (suspensões, luminárias embutidas, plafons). Somos certificados ISO 9001 e “garantia de origem França”. Temos um showroom em Paris..

- 40% de desconto sobre os preços públicos
- Custos logísticos: aprox. 5% (a definir conforme orçamento)
- Envio gratuito na França metropolitana: 500 €

#### CSR

- Trajetória 2030, redução das emissões de carbono ✓
- Produtos altamente recicláveis (alumínio) ✓
- Compras responsáveis ✓
- Raízes locais ✓

#### Services

- Sob medida e semi-medida ✓
- Todas as cores RAL ✓

#### Product Range

- Iluminação para espaços terciários ✓

#### APPLICATIONS

- Escritórios, salas de conferência, espaços de coworking
- Espaços habitáveis
- Circulações, corredores
- Áreas de bem-estar, spas, academias
- Restaurantes, bares
- Cozinhas
- Recepções, lobbies
- Lojas...

#### ProductionFrance

**Sourcing:** Local (40% less than 200km from the factory), National, Europe.

#### Furniture trade-in service

Yes on street lamps

#### Contact :

Ludovic Voltz  
Chief Executive Officer  
+33 6 99 54 31 08  
[l.voltz@radian.fr](mailto:l.voltz@radian.fr)

Showroom  
5 ter rue d'Arsonval  
75015 Paris

#### Certifications \*



#### EcoVadis Score

69/100

Silver Medal June 2024



[Website](#)



Wall lights



In-wall



Work Lights



Suspensions



Ceiling lights



EcoVadis PRATA Junho 2024  
As classificações da EcoVadis oferecem uma visão transparente e imparcial da nossa forma de trabalhar

Garantia de reparabilidade de 10 anos  
A Radian pode oferecer a reparabilidade das suas luminárias por um período de 10 anos.

Garantia técnica de 5 anos  
Os componentes e peças estão cobertos por uma garantia de 5 anos quando instalados e utilizados conforme previsto.

Roger Pradier®, fundada há mais de um século, é reconhecida pela sua iluminação exterior intemporal, fabricada perto de Châteauroux. Com uma garantia de 25 anos contra a corrosão do alumínio, as suas luminárias são concebidas para resistir a todas as condições climáticas. A empresa oferece uma ampla gama de estilos e soluções personalizáveis, ideais para profissionais de paisagismo. Roger Pradier® está empenhada em ajudar os hotéis e parceiros da Accor a criar espaços exteriores elegantes e sustentáveis.

•40% de desconto sobre os preços públicos  
 •Custos logísticos: aprox. 5% (a definir conforme orçamento)  
 •Envio gratuito na França metropolitana: 500 €

### CSR

- Trajetória 2030, redução das emissões de carbono
- Desenvolver uma metodologia de ecodesign
- Materiais reciclados
- Implementar uma abordagem de compras responsáveis
- Raízes locais, fabricação 100% francesa

### SERVICES

- Linha de produtos: iluminação decorativa para áreas externas  
 Opções: sob medida e semi sob medida
- Acabamentos: 25 cores e 5 materiais
- Garantias



### APPLICATIONS

- Áreas externas: fachadas, parques, jardins, acessos aos edifícios
- Terraços, varandas, coberturas
- Áreas ao redor das piscinas, solários
- Restaurantes, bares
- Áreas comuns externas: escadas, corredores, passagens
- Estacionamentos externo



*Hôtel du Palais,  
Biarritz  
Avenue 4 floor lamp*



*Hotel La Roya,  
Saint-Florent  
Tetra bollard*



*Hôtel La Fantaisie,  
Paris  
Louis-Philippe wall lamp 1*



*Hôtel Le Berria,  
Hasperren  
Lampioik 1 wall lamp*

**Production** Saint-Maur, France

**Sourcing** France and Europe  
 (87% of our suppliers are French, with 22% located less than 80km from our production site)

### Certifications

ISO 9001, CE, UL, EAC  
**EcoVadis score 2023:** Bronze 58/100

### Living Heritage Company label

French companies with excellent craft and industrial skills



### Commercial contacts

France, Spain, Portugal

Stéphane Aubry

+33 6 13 01 79 11

stephane.aubry@brossier-sademe.com

[imartinez@roger-pradier.com](mailto:imartinez@roger-pradier.com)



[www.roger-pradier.com](http://www.roger-pradier.com)

**Showroom** by appointment at 12 rue Lamartine – Paris 09

# SÉCURLITE



Desde 1986, **SÉCURLITE** fabrica e desenvolve soluções de iluminação duráveis e de alta resistência para arquitetos e escritórios de design, bem como para proprietários de edifícios e suas instalações. Para a Sécurlite, a iluminação deve combinar conforto, desempenho e durabilidade. As nossas gamas foram desenvolvidas para oferecer uma resposta funcional, fiável e segura a todas as necessidades de iluminação de edifícios públicos movimentados. Eco concebidos, os produtos das nossas gamas foram projetados para otimizar o consumo de energia dos estabelecimentos que equipam e reduzir drasticamente os custos de manutenção. A Sécurlite oferece uma gama completa de iluminação interior/exterior: luminárias circulares, downlights, luminárias lineares e embutidas, bem como soluções técnicas sob medida.

**-40% on the housing range**  
**-30% on technical range**  
**Logistics cost:** approx. 5% (to be refined according to quote)  
**Free shipping:** €500 excl. VAT in metropolitan France

CSR	SERVICES	APPLICATIONS
<b>Ética e Social</b> Produção inclusiva integrada no ESAT, patrocínio da Habitat & Humanisme  <b>Meio ambiente</b> ecodesign, reciclabilidade, reparabilidade <b>Fabricado na França</b>	<b>Linha Interior/Exterior</b> Opção detecção de presença  <b>Soluções técnicas</b> Sob medida  Retrofit para produto de segunda vida	Circulação Áreas comuns Salas de serviço Sanitários Varandas Exterior Estacionamento



[www.securlite.com](http://www.securlite.com)

Showroom at the head office in La Ferté-Bernard and by appointment at 12 Rue Lamartine – Paris 9

**Production** France  
**Sourcing** :France (99% de our suppliers are French)

**CERTIFICATIONS**  
 Iso 9001, **Origine France Garantie**, PEP ecopassport RGE étude d'éclairage intérieur  
  
**Score EcoVadis**  
 Or 71/100



**Business contacts:**  
 France / Spain / Portugal :

Stépha,e Aubry +33 6 13 01 79 11

stephane.aubry@brossier-saderne.com

# FERMOB



Na Fermob, a luz é como o mobiliário! Fácil de usar, inovadora, elegante e colorida, as nossas luminárias cumprem critérios rigorosos desde o design até à fabricação. Projetadas para serem colocadas, penduradas, transportadas ou fixadas, oferecem uma variedade de cenários de iluminação para múltiplos usos e uma experiência única para o utilizador. *uses and a unique user experience*



  
de desconto – Preços públicos sem impostos

## RSE

- ✓ Materiais reciclados
- ✓ Programa de segunda vida
- ✓ Eco concepção

## Services

- ✓ Produtos sob medida
- ✓ Modificação de produtos do catálogo

**Production :** France, Asie

**Sourcing :**

Serviço de recuperação:  
oui

## Certifications

IEC 60598, NF EN 62262, NF EN 60529  
IRCY, IREP

## Score EcoVadis

68/100



[Fermob-contract.com](https://www.fermob-contract.com)



Collections , MOON!, HOOPIK, LUXEMBOURG, STUDIE, KATE



Collections MOON!, SURPRISING, COCOTTE



Collection OTO



Collections BALAD, HOOPIK



Collection HOOPIK



Collection APLO

 **Contact :**

Agnès CAMACHO  
[acamacho@fermobcontractunit.com](mailto:acamacho@fermobcontractunit.com)  
Mobile : +33 (0)689 013 924

*Bureau:* Thoissey (01) - FRANCE



ASTORE

Faro Barcelona é uma empresa familiar espanhola criada em 1945. Especializada em iluminação decorativa interior, a Faro também oferece iluminação exterior e uma gama de ventiladores. Destaca-se pelo seu design original e identidade única.

**-35% nas tarifas públicas da Faro**

Eco-Midscale range

### RSE

- ✓ Materiais reciclados
- ✓ Programa de segunda vida
- ✓ Eco concepção

### Product range

- ✓ Produtos decorativos (aplique, candeeiros de pé, suspensões...)
- ✓ Produto arquitetónico (spots)
- ✓ Produtos sob medida

**Production :** ASIA – EUROPE

**Sourcing :** EUROPE - ASIA

**Take-back service**  
No

### Certifications



**EcoVadis Score**  
67/100



### Contact

Ana LOPEZ RAVENTOS  
Tél: +34 659 878 564  
[ana.lopez@faro.es](mailto:ana.lopez@faro.es)

Caroline Pérez  
Tél: +34 617 428 604  
[caroline.perez@faro.es](mailto:caroline.perez@faro.es)

[Website](#)



# FLOS PROJETO

-40% nas tarifas públicas da Flos

Midscale to Premium range

## RSE

- Materiais reciclados ✓
- Programa de segunda vida ✓
- Eco concepção ✓

## Product range

- Produtos decorativos (aplique, candeeiros de pé, suspensões...) ✓
- Produto arquitetónico (spots) ✓
- Produtos sob medida ✓

Production : ITALY – ESPAGNE

Sourcing : SOUTHERN EUROPE

## Certifications



## EcoVadis Score

TBC

## Take-back service

No



## Contact

**Spain:**  
Arantza MARTINEZ  
arantza.martinez@flos.com

**Italy:**  
Sirio GRECO  
[sirio.greco@flos.com](mailto:sirio.greco@flos.com)



[Website](#)

Showrooms: Milan, Rome, Paris, Lyon, Hong Kong, London, Copenhagen, Oslo, Amsterdam, Tokyo

Frandsen é um fornecedor dinamarquês especializado na indústria hoteleira. São muito flexíveis e não hesitarão em propor rapidamente um protótipo adaptado ao teu projeto: são especializados em produtos sob medida e podem trabalhar em estreita colaboração com as equipas de projeto.



## Negotiated prices on project basis

Bespoke only

### Product range

Produtos decorativos (aplique, candeeiros de pé, suspensões...)



Produto arquitetônico (spots)



Produtos sob medida



**EcoVadis Score**  
TBC



### Contact :

Karina Sorensen  
Tél: +45 76 58 18 18  
karina.sorensen@made-specific.com

Eco to Premium range



**FRANDSEN  
PROJECT**

LEDS-C4 é um fabricante espanhol que oferece tanto produtos de catálogo como produtos sob medida. Podem ter um grande stock e também trabalhar com pequenas quantidades, tudo a preços competitivos.



-60% nas tarifas públicas da LEDSC4

### RSE

- Materiais reciclados ✓
- Programa de segunda vida ✓
- Eco concepção ✓

### Product range

- Produtos decorativos (aplique, candeeiros de pé, suspensões...) ✓
- Produto arquitetónico (spots) ✓
- Produtos sob medida ✓

**Production :** EUROPE – SPAIN - ASIA

**Sourcing :** ASIA - EUROPE

### Take-back service

No

### Certifications



### EcoVadis Score

75/100



[Website](#)



### Contact

Carmen Reina  
Tél: +34 97 34 68 134  
carmenreina@leds-c4.com

*Showrooms: Barcelona, Moscow, Johannesburg, Casablanca, Dubai, Kuwait, Cairo, Bangkok, Singapour, Mexico, Caracas*

## LEDS C4

Maisons du Monde, inicialmente especializada em mobiliário sóto e decoração, expandiu a sua gama B2B com uma oferta de iluminação. Lançaram o seu próprio serviço de design de interiores, acompanhado por um designer de interiores para os teus projetos.

  
% a -14% nas tarifas públicas para todas as encomendas acima de 1.000€

### RSE

- Materials reciclados ✓
- Programa de segunda vida ✓
- Eco concepção ✗

### Product range

- Produtos decorativos (applique, candeeiros de pé, suspensões...) ✓
- Produto arquitetônico (spots) ✗
- Produtos sob medida ✓

**Production:** FRANCE, ASIA, EUROPE

**Sourcing:** EUROPE, ASIA

### Certifications



### Take-back service

Non

### EcoVadis Score

68/100



### Contact :

Fabienne Sacareau  
fsacareau@maisonsdumonde.comTTel:  
+33 08 54 05 52

 [Website](#)

### Eco-Midscale range

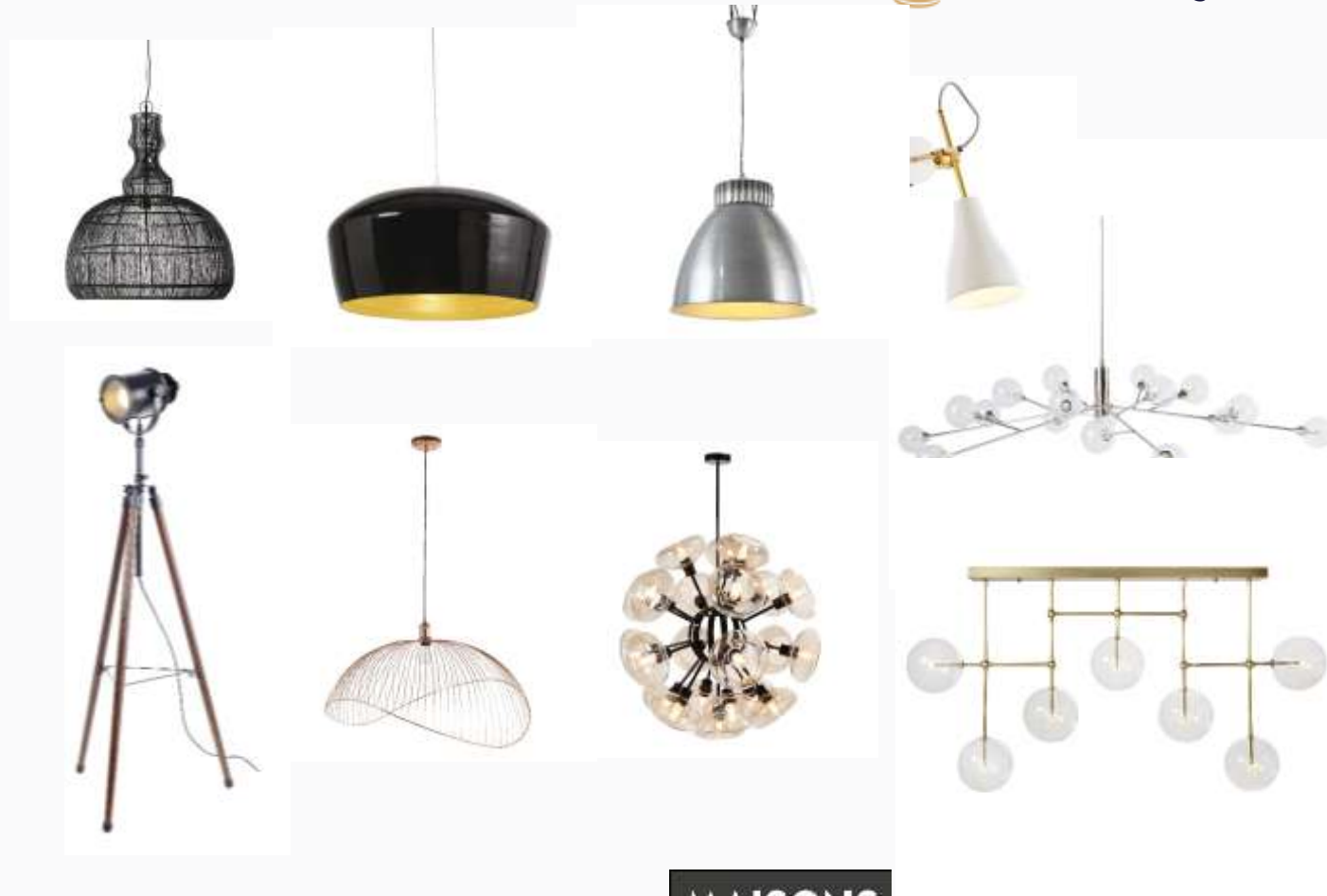

**Showrooms:** Maisons du Monde - 6 rue Anne de Bretagne - Immeuble Viséo - 44 120 Vertou (France)  
Maisons du Monde Show Room PRO: 5 boulevard Montmartre  
75002 Paris (France)

Targetti é um fabricante italiano com designs clássicos e contemporâneos. Podem produzir produtos sob medida mediante solicitação quando as quantidades encomendadas são suficientemente grandes.



-40%

nas tarifas públicas da Targetti

### Product range

Produtos decorativos e arquitetónicos (aplique, candeeiros de pé, suspensões, espelhos...)



### Produtos sob medida



[Targetti Website](#)

[MLE Website](#)

### EcoVadis Score

51/100



### Contact :

Nathalie Maia  
06 68 00 55 06

[nathalie.maia@targetti.com](mailto:nathalie.maia@targetti.com)

Showrooms: Paris, Singapour, Copenhagen, Stockholm, Düsseldorf, Fort Lauderdale, Tokyo, Oslo, Leewarden, Kriens (Switzerland), Helsinki.



Eco-Midscale range





## Furniture & Design

### ACCESSORIES

PIERRE PRADEL / MP GLASS

### BULBS

SIGNIFY

# List of Nominated Suppliers

PORTUGAL

# PIERRE PRADEL / MP GLASS

Há mais de 45 anos que a Pradel é uma marca francesa líder de espelhos de casa de banho profissionais. Focada exclusivamente no comércio profissional e no mercado hoteleiro, a Pradel oferece espelhos iluminados ou padrão, armários para banheiro e espelhos cosméticos de alta qualidade com designs inovadores. Com base na sua experiência na indústria de espelhos, e mais especificamente em espelhos iluminados, a missão da Pradel é oferecer-lhe produtos inovadores, de alta qualidade e eco-responsáveis que vão ao encontro das últimas tendências do mercado.



**-50%**

sobre os preços públicos do catálogo geral PRADEL

## RCS

Espelho sem chumbo sem cobre ✓

Reparabilidade do espelho ✓

5 anos de garantia ✓

**Produção** : EUROPA, ASIA

**Abastecimento**: EUROPA, ÁSIA

**Serviço pós-venda**  
**SIM**

## Servicios

Espelhos específicos para a hotelaria ✓

Uma equipa especializada ✓

Espelhos cosméticos topo de gama ✓

## Certificações



**EcoVadis:**  
67/100

Conceito Accor, espelho padrão, espelho personalizado e espelho cosmético de aumento



## Contatos:

Félix TRUONG - Tel: +33 7 48 10 05 42

Céline MAYENCON - Tel: +33 4 82 54 04 19

Mail : contact-hotel@pierrepradel.com



**Sítio web**

[www.pierrepradel.com](http://www.pierrepradel.com) / Para mais informações sobre os nossos produtos, por favor contacte-nos por telefone ou e-mail



**PRADEL**

Sede social: SAS MPglass, 408 allée des Filiéristes, 01600 Trévoux

**ASTORE**

# SIGNIFY











A Signify é líder mundial em iluminação. Oferecemos produtos, sistemas e serviços de alta qualidade e energeticamente eficientes. As nossas soluções de iluminação conectada: Ao redefinir o que a luz pode fazer e como as pessoas a utilizam, as nossas inovações contribuem para um mundo mais seguro, inteligente e sustentável.

As soluções MyCreation são luminárias impressas em 3D com materiais reciclados e recicláveis

Score EcoVadis  
84/100



Eco - Midscale - Upscale

 Contributing to the circular economy	 Solving CO2 emissions	 Disposing of waste
 The aim is to produce all printed parts with at least 65% recycled or bio-circular plastics.	 Up to 76% fewer emissions for materials supply and manufacturing	 No stock, no unsold stock thanks to print-on-demand
 up to 40% fewer components	 Up to 28% fewer carbon emissions from transport	 Using waste to create products
 Easy to dismantle		 towards zero waste production

## Distributors

[LEGALLAIS](#)

[SIDER](#)

[SONEPAR](#)

[REXEL](#)



<https://www.signify.com/global/myCreation> Iluminações

**Contato:**

**Laurent GUILLOT**

Laurent.guillot@signify.com

Mobile : +33 7 85 61 27 47



Oficina: Signify, 33 rue de Verdun, CS60019 - 92156 Suresnes



Signify  
myCreation

ASTORE



## SOFA BEDS

# List of Nominated Suppliers

PORTUGAL



## Furniture & Design



### CONVERTIBLE SOFAS

BK ITALIA

LIGNE ROSET

COLLINET

MADE IN DESIGN

DORELAN

POLE POSITION



### CONVERTIBLE ARMCHAIRS

DORELAN

MADE IN DESIGN



### TRUNDLE BEDS

BK ITALIA

DORELAN



### BUNK & GUEST BEDS

ADOVA

DORELAN



### DAYBEDS

BK ITALIA

DORELAN

MADE IN DESIGN

SOCA



### CONVERTIBLE OTTOMANS

BK ITALIA

DORELAN

# CONVERTIBLE SOFAS



# BK convertible sofa



BK Group é uma empresa italiana especializada na produção de sofás e poltronas conversíveis há 60 anos..

## Model BK 126



### PROPERTIES

- Espuma HR 40 kg/m<sup>3</sup>
- Garantia de 2 anos
- Custos de entrega: a calcular
- Espessura: 15 cm



### DIMENSIONS

- Dimensões totais: L191 x P90 cm
- Altura do assento: 44/45 cm

Score EcoVadis  
En cours/100



- Possibilidade de tecido do cliente
- Cama pré-montada
- Capa removível
- Espuma resistente ao fogo

## Model BK 127



### PROPERTIES

- Espuma HR 40 kg/m<sup>3</sup>
- Garantia de 2 anos
- Custos de entrega: a calcular
- Espessura: 15 cm



### DIMENSIONS

- Dimensões totais: L89 x P90 cm
- Altura do assento: 45 cm



- Sem correias
- Sem espaço de armazenamento



## CONTACT

FRANCE/EUROPE

Sara Mandelli  
[sara@bkitalia.com](mailto:sara@bkitalia.com)  
Tel: +39 03 63 48 971

# BK convertible sofa



BK Group é uma empresa italiana especializada na produção de sofás e poltronas conversíveis há 60 anos..

## Model BK 103



### PROPERTIES

- Material padrão
- Espuma HR 40 kg/m<sup>3</sup>
- Garantia de 2 anos
- Espessura: 15 cm



### DIMENSIONS

- Dimensões totais: L191 x P90 cm
- Altura do assento: 44/45 cm

Score EcoVadis  
/100



- Possibilidade de tecido do cliente
- Cama pré-montada
- Capa removível
- Espuma resistente ao fogo

## Model BK 108



### PROPERTIES

- Espuma HR 40 kg/m<sup>3</sup>
- Garantia de 2 anos
- Espessura: 15 cm



### DIMENSIONS

- Dimensões totais: L165 x P90 cm
- Altura do assento: 45 cm



- Sem correias
- Sem espaço de armazenamento



## CONTACT

FRANCE/EUROPE

Sara Mandelli  
[sara@bkitalia.com](mailto:sara@bkitalia.com)  
Tel: +39 03 63 48 971

# BK convertible sofa



BK Group é uma empresa italiana especializada na produção de sofás e poltronas conversíveis há 60 anos..

## Model BK 103



### PROPERTIES

- Material padrão
- Espuma HR 40 kg/m<sup>3</sup>
- Garantia de 2 anos
- Espessura: 15 cm



### DIMENSIONS

- Dimensões totais: L191 x P90 cm
- Altura do assento: 44/45 cm

Score EcoVadis  
/100



- Possibilidade de tecido do cliente
- Cama pré-montada
- Capa removível
- Espuma resistente ao fogo

## Model BK 108



### PROPERTIES

- Espuma HR 40 kg/m<sup>3</sup>
- Garantia de 2 anos
- Espessura: 15 cm



### DIMENSIONS

- Dimensões totais: L165 x P90 cm
- Altura do assento: 45 cm



- Sem correias
- Sem espaço de armazenamento



## CONTACT

FRANCE/EUROPE

Sara Mandelli  
[sara@bkitalia.com](mailto:sara@bkitalia.com)  
Tel: +39 03 63 48 971

# BK convertible sofa



BK Group é uma empresa italiana especializada na produção de sofás e poltronas conversíveis há 60 anos..

## Model BK 102



### PROPERTIES

- Material padrão
- Espuma HR 40 kg/m<sup>3</sup>
- Garantia de 2 anos
- Custos de entrega: a calcular
- Espessura: 15 cm



### DIMENSIONS

- Dimensões totais: L191 x P90 cm
- Altura do assento: 44/45 cm

Score EcoVadis  
/100



- Possibilidade de tecido do cliente
- Cama pré-montada
- Capa removível
- Espuma resistente ao fogo

## Model BK 118



### PROPERTIES

- Espuma HR 40 kg/m<sup>3</sup>
- Garantia de 2 anos
- Custos de entrega: a calcular
- Espessura: 15 cm



### DIMENSIONS

- Dimensões totais: L166 x P90 cm
- Altura do assento: 45 cm



- Sem correias
- Sem espaço de armazenamento



## CONTACT

FRANCE/EUROPE

Sara Mandelli  
[sara@bkitalia.com](mailto:sara@bkitalia.com)  
Tel: +39 03 63 48 971

# BK convertible sofa



BK Group é uma empresa italiana especializada na produção de sofás e poltronas conversíveis há 60 anos..

## Model BK 126 (special)



### PROPERTIES

- Material padrão
- Espuma HR 40 kg/m<sup>3</sup>
- Garantia de 2 anos
- Custos de entrega: a calcular
- Espessura: 15 cm



### DIMENSIONS

- Dimensões totais: L191 x P90 cm
- Altura do assento: 44/45 cm

Score EcoVadis  
/100



- Customer fabric available
- Pre-made bed
- Removable cover
- Fire-retardant foam

## Model BK 103 DECL

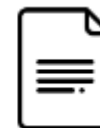

### PROPERTIES

- Espuma HR 40 kg/m<sup>3</sup>
- Garantia de 2 anos
- Custos de entrega: a calcular
- Espessura: 15 cm



### DIMENSIONS

- Dimensões totais: L166 x P90 cm
- Altura do assento: 45 cm



- No straps
- No storage space



## CONTACT

FRANCE/EUROPE

Sara Mandelli  
[sara@bkitalia.com](mailto:sara@bkitalia.com)  
Tel: +39 03 63 48 971

# COLLINET convertible sofa



Desde 1887, a Collinet combina experiência e qualidade. O fabricante francês conta com o profissionalismo de cerca de 100 colaboradores para oferecer móveis de linhas simples, modernos e respeitadores dos estilos tradicionais..

## EASY model



### PROPERTIES

- Mecanismo de alta qualidade com dobras
- Densidade 25 kg/m<sup>3</sup>
- Espessura 13 cm
- Garantia legal de 2 anos



### DIMENSIONS

- Profundidade: 100 cm
- Altura: 90 cm
- Altura do assento: 50 cm
- Dimensões totais quando aberto: 210 cm
- Opções de largura conforme o tamanho da cama em 190 cm (70-120-140-160-2x70 cm) e escolha dos apoios de braço

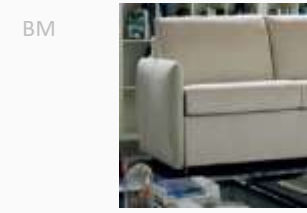

Score EcoVadis  
30/100

- larguras de cama disponíveis (de poltrona a sofá de 3 lugares)
- Várias opções de braços (6 modelos)
- Capas removíveis
- Espuma retardante de fogo (opcional)
- Espaço para guardar almofadas



Plazo de entrega: 10 semanas



## CONTACT

FRANCE/EUROPE

Virginie Collinet  
[virginie@collinet-sieges.fr](mailto:virginie@collinet-sieges.fr)  
+33 (0)6 85 71 84 84

# COLLINET convertible sofa



Desde 1887, a Collinet combina experiência e qualidade. O fabricante francês conta com o profissionalismo de cerca de 100 colaboradores para oferecer móveis de linhas simples, modernos e respeitadores dos estilos tradicionais..

## SIBU model



### PROPERTIES

- Mecanismo de alta qualidade com 2 dobras
- Densidade 25 kg/m<sup>3</sup>
- Espessura 12 cm
- Garantia legal de 2 anos



### DIMENSIONS

- Profundidade: 105 cm
- Altura: 91 cm
- Altura do assento: 50 cm
- Dimensões quando aberto: 210 cm
- Opções de largura conforme a roupa de cama em 190 cm (70-120-140-160 cm)



1



3



4



Score EcoVadis  
30/100

- 4 larguras de cama disponíveis (de poltrona a sofá de 3 lugares)
- Possibilidade de usar o tecido do cliente
- Capas removíveis
- Espuma retardante de fogo (opcional)
- Espaço para guardar almofadas



Plazo de entrega: 10 semanas



## CONTACT

FRANCE/EUROPE

Virginie Collinet  
[virginie@collinet-sieges.fr](mailto:virginie@collinet-sieges.fr)  
+33 (0)6 85 71 84 84

# COLLINET convertible sofa



Desde 1887, a Collinet combina experiência e qualidade. O fabricante francês conta com o profissionalismo de cerca de 100 colaboradores para oferecer móveis de linhas simples, modernos e respeitadores dos estilos tradicionais..

## Mélia model



### PROPERTIES

- Mecanismo deslizante de alta qualidade
- Densidade 25 kg/m<sup>3</sup>
- Espessura 15 cm
- Garantia legal de 2 anos



### DIMENSIONS

- Profundidade x comprimento: 208 x 92 cm
- Altura: 71 cm
- Altura do assento: 50 cm
- Cama superior: 195 x 85 cm e cama inferior: 185 x 80 cm



Score EcoVadis  
30/100

- Cama extra com elevação automática
- Possibilidade de usar o tecido do cliente
- Capa removível
- Espuma retardante de fogo (opcional)
- Gaveta de armazenamento ou cama extra



## CONTACT

FRANCE/EUROPE

Virginie Collinet  
[virginie@collinet-sieges.fr](mailto:virginie@collinet-sieges.fr)  
+33 (0)6 85 71 84 84

# DORELAN convertible sofa



dorelan®  
dormire bene vivere meglio

A DORELAN, fabricante líder de roupa de cama e sofás conversíveis na Itália, foi fundada em Forlì em 1968..

## Patrick model



### PROPERTIES

- Fácil de abrir inclinando o encosto graças a uma alça
- Densidade 45 kg/m<sup>3</sup>
- Espessura 15 cm (também disponível em 11 cm)
- Garantia de 24 meses



### DIMENSIONS

- Dimensões totais\*: a partir de L165 x P98 cm

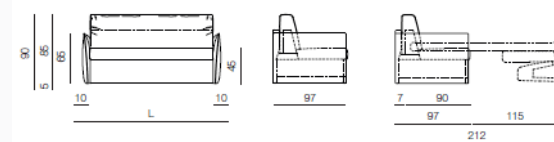

- Versões L: colchão Delight medindo 120/140/160 x 190 x h.11 cm com altura do assento do sofá-cama de 45 cm

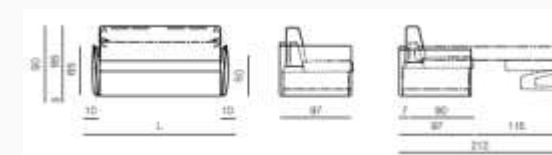

- Versão H: colchão Delight medindo 120/140/160 x 190 x h.15 cm com assento do sofá-cama a uma altura de 50 cm
- Todas as versões H estão disponíveis com um colchão Delight de 200 cm de comprimento (espessura 11 cm)

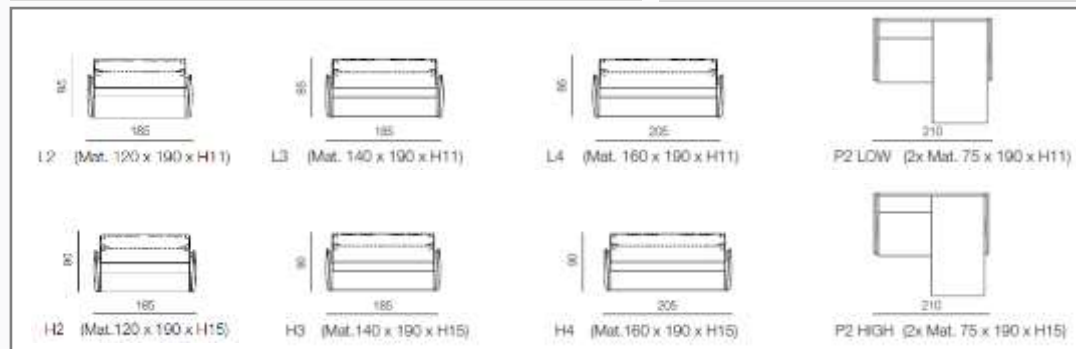

- Possibilidade de usar o tecido do cliente
  - Espuma à prova de fogo
  - Capa removível
  - Espaço de armazenamento
  - A cama pode ser pré-montada sob pedido
- 160 capas e cores disponíveis

Score EcoVadis

68/100



**CONTACT**  
FRANCE/EUROPE

Mirko de Lucia  
m.delucia@dorelan.it  
Tel: +33 7 72 36 58 84

As dimensões "totais" dos modelos Dorelan são fornecidas apenas para fins informativos. Pode ocorrer uma tolerância dimensional de 3 a 5% em todos os materiais, incluindo tecidos e estofados.

# DORELAN convertible sofa



dorelan®  
dormire bene vivere meglio

A DORELAN, fabricante líder de roupa de cama e sofás conversíveis na Itália, foi fundada em Forli em 1968..

## Andrew P2 LOW or HIGH model



### PROPERTIES

Fácil de abrir inclinando o encosto graças a uma alça

- Densidade 45 kg/m<sup>3</sup>
- Espessura 15 cm (também disponível em 11 cm)
- Garantia de 24 meses



### DIMENSIONS

- Dimensões totais\*: a partir de L195 x P98 cm

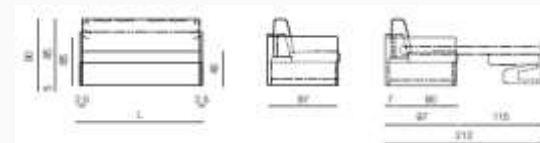
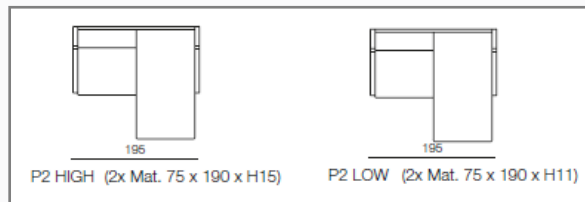

- Versões P2L: colchão Delight medindo 2x75x190 x h.11 cm com altura do assento do sofá-cama de 45 cm



- versao P2H: colchao Delight medindo 2x75x190 x h.15 cm com altura do assento do sofá-cama conversível de 50 cm
- Todas as versões H estão disponíveis com um colchão Delight de 200 cm de comprimento (espessura 11 cm)

As dimensões "totais" dos modelos Dorelan são fornecidas apenas para fins informativos. Pode ocorrer uma tolerância dimensional de 3 a 5% em todos os materiais, incluindo tecidos e estofados



- Possibilidade de usar o tecido do cliente
- Espuma à prova de fogo
- Capa removível
- Espaço de armazenamento
- A cama pode ser pré-montada sob pedido
- ☐ 160 fundas y colores disponibles

Score EcoVadis

68/100



 **CONTACT**  
FRANCE/EUROPE

Mirko de Lucia  
m.delucia@dorelan.it  
Tel: +33 7 72 36 58 84

# DORELAN convertible sofa



dorelan®  
dormire bene vivere meglio

A DORELAN, fabricante líder de roupa de cama e sofás conversíveis na Itália, foi fundada em Forli em 1968.

## George model L



### PROPERTIES

Fácil de abrir inclinando o encosto graças a uma alça

- Densidade 45 kg/m<sup>3</sup>
- Espessura 15 cm (também disponível em 11 cm)
- Garantia de 24 meses



### DIMENSIONS

- Dimensões totais\*: a partir de Largura 125 x Profundidade 98 cm

As fotos são meramente ilustrativas e não constituem um compromisso contratual. As versões L1, L1\_90 e H1 são poltronas com uma única almofada de encosto e uma única almofada de assento

As dimensões "totais" dos modelos Dorelan são fornecidas apenas para fins informativos. Pode ocorrer uma tolerância dimensional de 3 a 5% em todos os materiais, incluindo tecidos e estofados

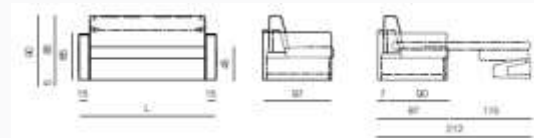

- Versões L: Colchão Delight medindo 75/90/100 x 190 x A.11 cm com altura do assento do sofá-cama de 45 cm.

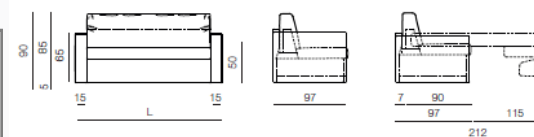

- Versão H: Colchão Delight medindo 75/100 x 190 x A.15 cm com altura do assento do sofá conversível de 50 cm. Todas as versões H estão disponíveis com um colchão Delight de 200 cm de comprimento (espessura de 11 cm)

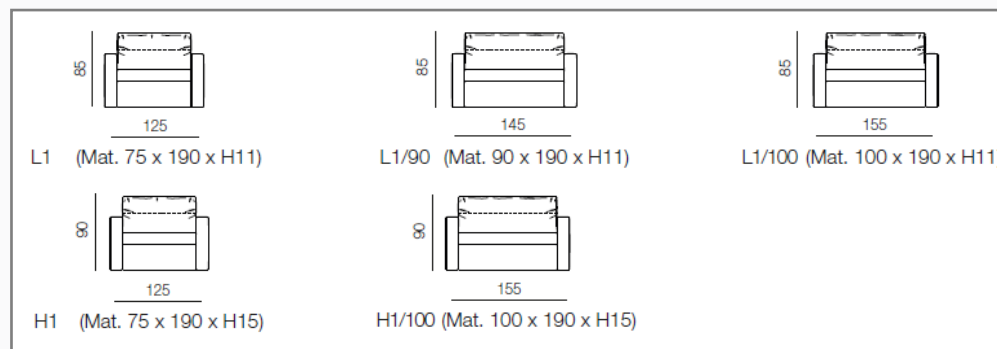

- Possibilidade de usar o tecido do cliente
  - Espuma à prova de fogo
  - Capa removível
  - Espaço de armazenamento
  - A cama pode ser pré-montada sob pedido
- 160 fundas y colores disponibles

Score EcoVadis  
68/100



**CONTACT**  
FRANCE/EUROPE

Mirko de Lucia  
m.delucia@dorelan.it  
Tel: +33 7 72 36 58 84

# DORELAN convertible sofa



dorelan®  
dormire bene vivere meglio

A DORELAN, fabricante líder de roupa de cama e sofás conversíveis na Itália, foi fundada em Forli em 1968..  
**Patrick model**



## PROPERTIES

Fácil de abrir inclinando o encosto graças a uma alça

- Densidade 45 kg/m<sup>3</sup>
- Espessura 15 cm (também disponível em 11 cm)
- Garantia de 24 meses



## DIMENSIONS

- Dimensões totais\*: a partir de L115 x P98 cm

As fotos são meramente ilustrativas e não constituem um compromisso contratual. As versões L1, L1\_90 e H1 são poltronas com uma única almofada de encosto e uma única almofada de assento

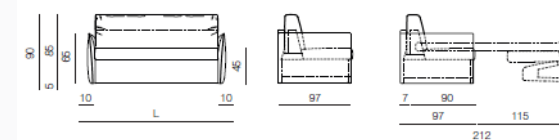

- Versões L: Colchão Delight medindo 75/90/100 x 190 x A.11 cm com altura do assento do sofá-cama de 45 cm

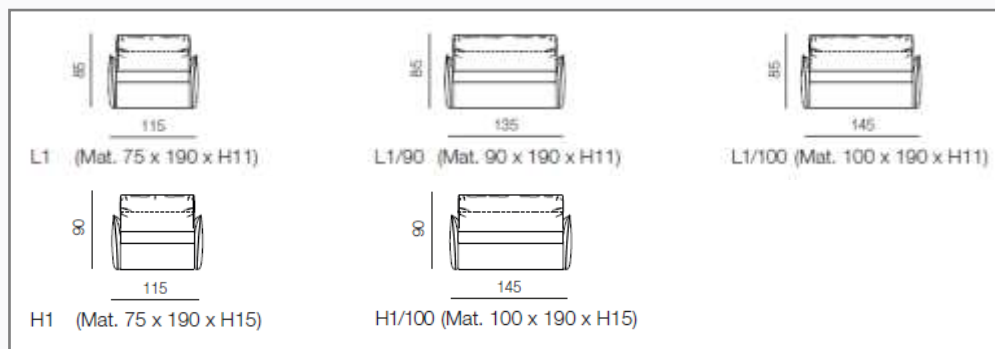
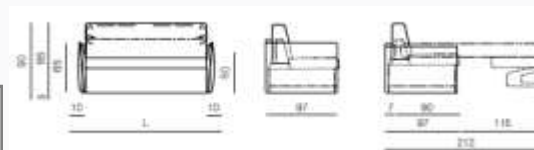

- Versão H: Colchão Delight medindo 75/100 x 190 x A.15 cm com altura do assento do sofá conversível de 50 cm. Todas as versões H estão disponíveis com um colchão Delight de 200 cm de comprimento (espessura de 11 cm)



- Possibilidade de usar o 1  160 fundas y colores disponibles
- Espuma à prova de fogo
- Capa removível
- Espaço de armazenamento
- A cama pode ser pré-montada sob pedido

Score EcoVadis  
68/100



**CONTACT**  
FRANCE/EUROPE

Mirko de Lucia  
m.delucia@dorelan.it  
Tel: +33 7 72 36 58 84

# LIGNE ROSET convertible sofa

Fundada em 1860, a Ligne Roset é uma empresa francesa especializada no fabrico de assentos e mobiliário. Eles podem fornecer soluções personalizadas. As suas fábricas são especializadas em estofamento, corte e colagem de espuma, corte de couro e tecido, e tratamento de superfícies de madeira..



ligne roset

## CLAM model

### PROPERTIES



Sistema de abertura fácil  
Espessura: 17 cm  
2 posições: sofá e cama



### DIMENSIONS



Sofá: L242 x 105 x 89 cm  
Altura do assento: 40 cm

Score EcoVadis  
55/100



Capa removível por um profissional  
Espuma resistente ao fogo



Sem espaço de armazenamento

Modelo: NÃO PERTURBE Área de dormir: 140 ou 160 Com ou sem mecanismo elétrico

### PROPERTIES



Sistema de abertura fácil  
Grosor: 14 cm  
2 posiciones: sofá o cama



### DIMENSIONS

Sistema de abertura fácil  
Espessura: 14 cm  
2 posições: sofá ou cama



**CONTACT**

FRANCE/EUROPE

Max Flageollet  
[mflageollet@roset.fr](mailto:mflageollet@roset.fr)  
+33 (0) 6 80 89 08 09

# Made in Design convertible sofa

Made In Design é o líder europeu em vendas online de mobiliário, iluminação e decoração de design, oferecendo produtos das maiores marcas (Kartell, Hay, Foscarini, etc.) e designers (Starck, Dixon, etc.)

## Chloé model - BOLIA



### PROPERTIES

Sistema de abertura tecnológico  
Densidade 35 kg/m<sup>3</sup>  
Garantia de 24 meses  
Entrega  
Dimensões para dormir: 215 x 190 cm



### DIMENSIONS

Dimensões totais: C214 x 116 x 86 cm  
Altura do assento: 57 cm



Score EcoVadis  
52/100



Assento de cintas  
Cama pré-montada a pedido

## Model: Up/Lift - PROSTORIA



### PROPERTIES

Rebater a parte superior do encosto  
Densidade 35 kg/m<sup>3</sup>  
Garantia de 24 meses  
Envio  
Espessura: 14 cm



### DIMENSIONS

Dimensões totais: C160 x 76 x 120  
Altura do assento: 44 cm



Sem espaço de armazenamento  
Sem espuma ignífuga  
Sem tecido do cliente disponível  
Capa não removível



### CONTACT

FRANCE/EUROPE

LASSALLE Charlène  
[charlene.lassalle@madeindesign.com](mailto:charlene.lassalle@madeindesign.com)  
+33 (0)4.38.12.34.75

# Made in Design convertible sofa



made in design ●●●  
*I live design*

Made In Design é o líder europeu em vendas online de mobiliário, iluminação e decoração de design, oferecendo produtos das maiores marcas (Kartell, Hay, Foscarini, etc.) e designers (Starck, Dixon, etc.).

## Fade model - PROSTORIA



### PROPERTIES

Sistema de abertura tecnológico

Densidade 35 kg/m<sup>3</sup>

Garantia de 24 meses

Entrega

Dimensões para dormir: 140 x 200 cm



### DIMENSIONS

Dimensões totais: C246 x 108 x 76

Altura do assento: 40 cm



Score EcoVadis  
52/100



Assento de cintas  
Espuma ignífuga  
Tecido do cliente disponível



A cama não pode ser pré-montada



**CONTACT**

FRANCE/EUROPE

LASSALLE Charlène

[charlene.lassalle@madeindesign.com](mailto:charlene.lassalle@madeindesign.com)

+33 (0)4.38.12.34.75

Website:

[www.madeindesign.com](http://www.madeindesign.com)

# Made in Design convertible sofa



made in design ●●●  
*I live design*

Made In Design é o líder europeu em vendas online de mobiliário, iluminação e decoração de design, oferecendo produtos das maiores marcas (Kartell, Hay, Foscarini, etc.) e designers (Starck, Dixon, etc.)

## Scandinavia model - BOLIA



### PROPERTIES

Sistema de abertura tecnológico  
Densidade 35 kg/m<sup>3</sup>  
Garantia de 24 meses  
Entrega  
Dimensões para dormir: 200 x 218 cm



### DIMENSIONS

Dimensões totais: C200 x 100 x 78 cm  
Altura do assento: 45 cm

Score EcoVadis  
52/100



Opção de pré-montar a cama



Sem espuma ignífuga  
Sem espaço de armazenamento  
Sem tecido do cliente  
Capa não removível



### CONTACT

FRANCE/EUROPE

LASSALLE Charlène  
[charlene.lassalle@madeindesign.com](mailto:charlene.lassalle@madeindesign.com)  
+33 (0)4.38.12.34.75

Pole Position, um fabricante francês de sofás desde 1991, reflete o artesanato francês. Cada sofá é feito à mão por artesãos qualificados usando métodos de fabricação industrial

**Preços de catálogo -10% para Accor**  
**Preços negociados por projeto**

**RSE**  
Materiais reciclados x  
Programa Segunda Vida  
Concepção ecológica

**Product range**  
Sofás conversíveis, fixos, com capa removível, modulares, capas separadas disponíveis

Production: FRANCE  
Sourcing: FRANCE & EUROPE  
Return service: Disponível sob consulta

Customisation available  
Certifications:

**EcoVadis Score:** TBC



Range Eco - Midscale - Upscale



Pole Position, um fabricante francês de sofás desde 1991, reflete o artesanato francês. Cada sofá é feito à mão por artesãos qualificados usando métodos de fabricação industrial

**Preços de catálogo -10% para Acco**  
**Preços negociados por projeto**

- RSE**
- ✓ Materiais reciclados x
  - Programa Segunda Vida
  - ✓ Conceção ecológica

**Product range**

Sofás conversíveis, fixos, com capa removível, modulares, capas separadas disponíveis

✓ Customisation available

✓ Certifications:



**EcoVadis Score:** TBC

**Production:** FRANCE

**Sourcing:** FRANCE & EUROPE

**Return service:**

Disponível sob consulta

**Contact:**

Valentine Thevenin  
 Mobile: +33 6 33 31 11 87  
 valentine.thevenin@home-and-furniture.netplalarme@homespirit.fr



Range Eco - Midscale - Upscale

**AMALIA**

137 cm coustige: 80x195 cm	137 cm coustige: 100x195 cm
137 cm coustige: 120x195 cm	137 cm coustige: 140x195 cm
	94 cm
217 cm coustige: 140x195 cm	

**ASTRID**

144 cm coustige: 80x195 cm	144 cm coustige: 100x195 cm
144 cm coustige: 100x195 cm	144 cm coustige: 140x195 cm
	94 cm
224 cm coustige: 140x195 cm	

Pole Position, um fabricante francês de sofás desde 1991, reflete o artesanato francês. Cada sofá é feito à mão por artesãos qualificados usando métodos de fabricação industrial

**Preços de catálogo -10% para Acco**  
**Preços negociados por projeto**

Range Eco - Midscale - Upscale

- RSE**
- ✓ Materiais reciclados x
  - Programa Segunda Vida
  - ✓ Conceção ecológica

**Product range**

Sofás conversíveis, fixos, com capa removível, modulares, capas separadas disponíveis



✓ Customisation available  
 Certifications:

**Production:** FRANCE  
**Sourcing:** FRANCE & EUROPE  
**Return service:**  
 Disponível sob consulta



**EcoVadis Score:** TBC

**Contact:**  
 Valentine Thevenin  
 Mobile: +33 6 33 31 11 87  
 valentine.thevenin@home-and-furniture.netplalarme@homespirit.fr



Pole Position, um fabricante francês de sofás desde 1991, reflete o artesanato francês. Cada sofá é feito à mão por artesãos qualificados usando métodos de fabricação industrial

**Preços de catálogo -10% para Acco**  
**Preços negociados por projeto**

Range Eco - Midscale - Upscale

**RSE**  
Materiais reciclados x  
Programa Segunda Vida  
Concepção ecológica

**Product range**  
Sofás conversíveis, fixos, com capa removível, modulares, capas separadas disponíveis

✓ Customisation available

✓ Certifications:

**Production:** FRANCE

**Sourcing:** FRANCE & EUROPE

**Return service:**

Disponível sob consulta

**Contact:**

Valentine Thevenin  
Mobile: +33 6 33 31 11 87  
valentine.thevenin@home-and-furniture.netplalarme@homespirit.fr



**EcoVadis Score:** TBC



# CONVERTIBLE ARMCHAIRS



# DORELAN convertible armchair



dorelan®  
dormire bene vivere meglio

A DORELAN, líder italiana no setor de colchões e sofás conversíveis, foi fundada em Forli em 1968

## Andrew model



### PROPERTIES

- Fácil de abrir inclinando o encosto graças a uma alça

Densidade 45 kg/m<sup>3</sup>

Espessura 11 cm (também disponível em 15 cm)

Garantia de 24 meses



### DIMENSIONS

- Dimensões totais\*: de C 100 x P 98 cm

As fotos são meramente ilustrativas e não constituem um compromisso contratual. As versões L1, L1\_90 e H1 são poltronas com uma única almofada de encosto e uma única almofada de assento.

As dimensões gerais dos modelos Dorelan são fornecidas apenas para fins informativos. Pode ser observada uma tolerância dimensional de 3 a 5% para todos os materiais que compreendem têxteis e estofos.

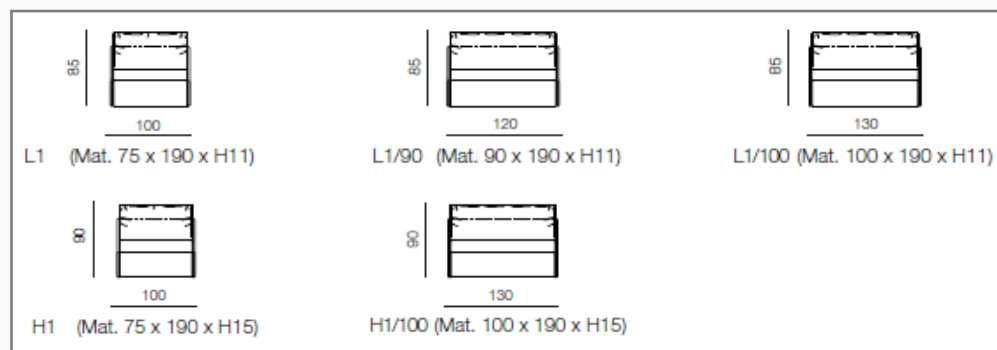

- Tecido do cliente disponível
- Espuma ignífuga
- Capas removíveis
- Espaço de armazenamento
- Cama pré-montada a pedido
- 160 tecidos e cores de estofamento disponíveis

Score EcoVadis

68/100



**CONTACT**  
FRANCE/EUROPE

Mirko de Lucia  
m.delucia@dorelan.it  
Tel: +33 7 72 36 58 84

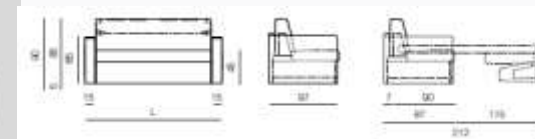

- Versões L: Colchão Delight medindo 75/90/100 x 190 x a.11 cm com altura do assento do sofá-cama de 45 cm

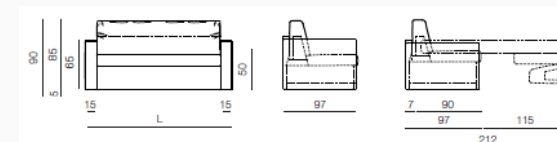

- Versão H: Colchão Delight medindo 75/100 x 190 x a.15 cm com assento de sofá conversível a uma altura de 50 cm. Todas as versões H estão disponíveis com um colchão Delight de 200 cm de comprimento (espessura de 11 cm)

# Convertible armchairs Made in Design



made in design ●●●

*I live design*

Made In Design é o líder europeu em vendas online de móveis, iluminação e decoração de design, oferecendo produtos das maiores marcas (Kartell, Hay, Foscarini, etc.) e designers (Starck, Dixon, etc.).

## Silver model – SOFTLINE DK



### PROPERTIES

Garantia de 24 meses  
Envio  
Dimensões para dormir: 56 x 196 cm



### DIMENSIONS

Dimensões totais: C100 x 86 x 73  
Altura do assento: 38 cm



Score EcoVadis  
49/100



Espuma ignífuga

## Up/lift model - PROSTORIA



### PROPERTIES

Rebater a parte superior do encosto  
Densidade 35 kg/m<sup>3</sup>  
Garantia de 24 meses  
Envio



### DIMENSIONS

Dimensões totais: C80 x 76 x 120  
Altura do assento: 44 cm



- Sem espaço de arrumação
- Não há tecido do cliente disponível
- Capa não removível
- Sem opção de fazer a cama com antecedência



## CONTACT

FRANCE/EUROPE

LASSALLE Charlène  
[charlene.lassalle@madeindesign.com](mailto:charlene.lassalle@madeindesign.com)  
+33 (0)4.38.12.34.75

# TRUNDLE BEDS



# BK pull-out bed



BK Group é uma empresa italiana que se especializou na produção de sofás e poltronas conversíveis há 60 anos

## Model BK 115



### PROPERTIES

Espuma HR 40 kg/m<sup>3</sup>  
Garantia de 2 anos  
Custos de entrega: a calcular  
Espessura: 15 cm



### DIMENSIONS

Dimensões totais: C240 x P90 cm  
Altura do assento: 47 cm



Score EcoVadis  
43/100



- Tecido do cliente disponível
- Cama pronta
- Capas removíveis
- Espuma retardadora de chamas



- Sem alças
- Sem espaço de armazenamento



**CONTACT**  
FRANCE/EUROPE

Sara Mandelli  
[sara@bkitalia.com](mailto:sara@bkitalia.com)  
Tel: +39 03 63 48 971

# DORELAN pull-out beds



dorelan®  
dormire bene vivere meglio

A DORELAN, fabricante líder de roupa de cama e sofás-cama da Itália, foi fundada em Forli em 1968.

## ROSY model



### PROPERTIES

- Densidade 45 kg/m<sup>3</sup>
- Espessura 15 cm
- Garantia de 24 meses
- Sistema Easyflip®: fácil inversão do assento
- Sistema Extra: cama auxiliar extraível
- Sistema Space: gaveta que economiza espaço



### DIMENSIONS

- Dimensões totais\*: de C 205xA 100 cm
- Altura do assento: 45 cm

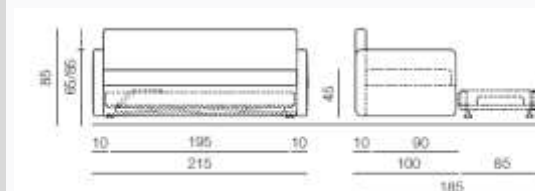
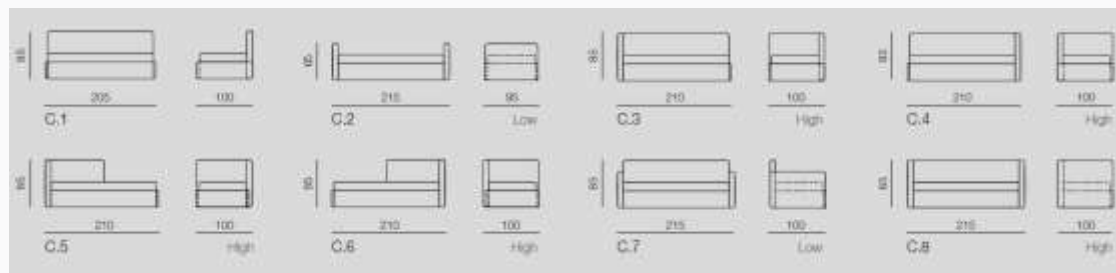

- Tecido do cliente disponível
- Espuma retardadora de chamas
- Capa removível
- Cama pode ser pré-montada a pedido
- Sistema Easyflip®

- 160 revestimentos e cores disponíveis
- Sistema Extra
- Sistema Space



- Sem alças

Score EcoVadis  
68/100



**CONTACT**

FRANCE/EUROPE

Mirko de Lucia  
m.delucia@dorelan.it  
Tel: +33 7 72 36 58 84

\*As dimensões gerais dos modelos Dorelan são fornecidas apenas para fins informativos. Uma tolerância dimensional de 3 a 5% pode ser observada para todos os materiais que compreendem têxteis e estofamento

# DORELAN pull-out beds



dorelan®  
dormire bene vivere meglio

A DORELAN, fabricante líder de roupa de cama e sofás-cama da Itália, foi fundada em Forli em 1968.

## ***CHERIE S model***



### **PROPERTIES**

- Density 45 kg/m<sup>3</sup>
- Thickness 15 cm
- 24-month warranty
- Easyflip® system: easy seat reversal
- Extra system: pull-out trundle bed
- Space system: space-saving drawer

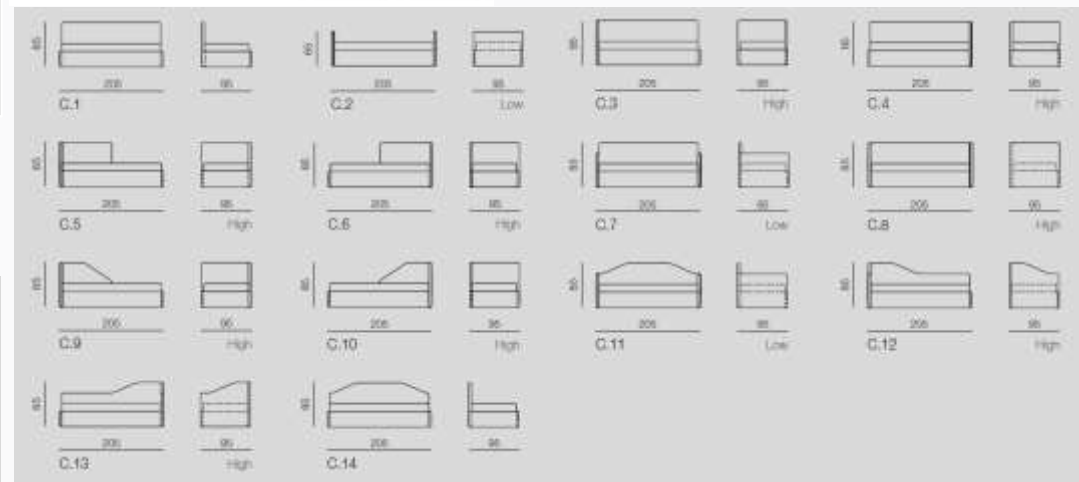
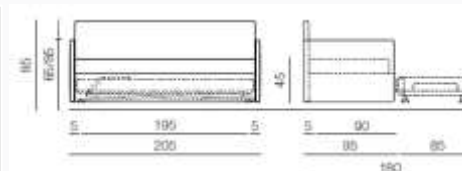

### **DIMENSIONS**

- Overall dimensions\*: from L205 x D95 cm
- Seat height: 45 cm

\*As dimensões gerais dos modelos Dorelan são fornecidas apenas para fins informativos. Uma tolerância dimensional de 3 a 5% pode ser observada para todos os materiais que compreendem têxteis e estofamento



- Tecido do cliente disponível
- Espuma retardadora de chamas
- Capa removível
- Cama pode ser pré-montada a pedido
- Sistema Easyflip®



- 160 revestimentos e cores
- Sem alças disponíveis
- Sistema Extra
- Sistema Space

Score EcoVadis  
68/100



 **CONTACT**  
FRANCE/EUROPE

Mirko de Lucia  
m.delucia@dorelan.it  
Tel: +33 7 72 36 58 84

# DORELAN pull-out bed



dorelan®  
dormire bene vivere meglio

ADORELAN, fabricante líder de roupa de cama e sofás-cama da Itália, foi fundada em Forli em 1968.

## DOROTHY model



### PROPERTIES

- Density 45 kg/m<sup>3</sup>
- Thickness 15cm
- 24-month warranty
- Easyflip® system: easy seat reversal
- Space system: space-saving drawer
- Extra system: pull-out trundle bed



### DIMENSIONS

- Overall dimensions\*: from L 205 x D 100 cm
- Seat height: 42 cm

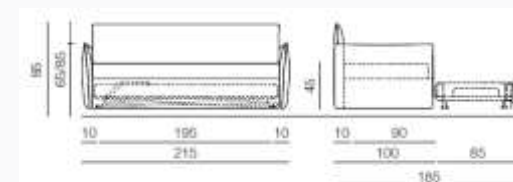
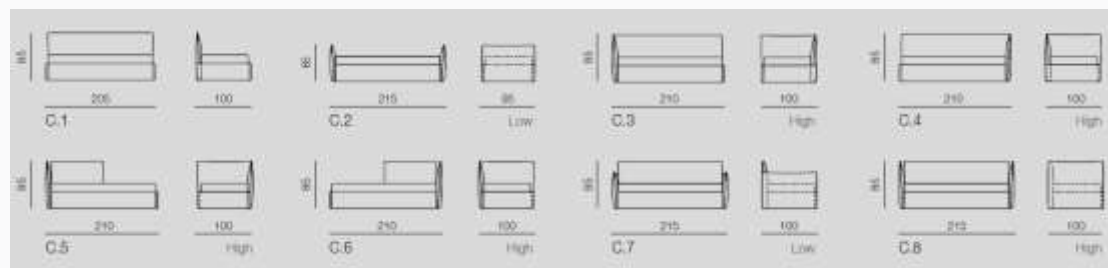

- Tecido do cliente disponível
- Espuma retardadora de chamas
- Capa removível
- Cama pode ser pré-montada a pedido
- Sistema Easyflip®
- 160 revestimentos e cores disponíveis
- Sistema Extra
- Sistema Space



- Sem alças 68/100

Score EcoVadis



 **CONTACT**  
FRANCE/EUROPE

Mirko de Lucia  
m.delucia@dorelan.it  
Tel: +33 7 72 36 58 84

\*As dimensões gerais dos modelos Dorelan são fornecidas apenas para fins informativos. Uma tolerância dimensional de 3 a 5% pode ser observada para todos os materiais que compreendem têxteis e estofamento

# DORELAN pull-out bed



dorelan®  
dormire bene vivere meglio

A DORELAN, fabricante líder de roupa de cama e sofás-cama da Itália, foi fundada em Forli em 1968.

## DOROTHY model



### PROPERTIES

- Densidade 45 kg/m<sup>3</sup>
- Espessura 15 cm
- Garantia de 24 meses



### DIMENSIONS

- Dimensões totais: C 210 x P 100 cm
- Altura do assento: 42 cm



- Tecido do cliente disponível
- Espuma retardadora de chamas
- Capa removível
- Cama pode ser pré-montada a pedido



- Sem alças
- Sem espaço de arrumação

Score EcoVadis  
68/100



 **CONTACT**  
FRANCE/EUROPE

Mirko de Lucia  
m.delucia@dorelan.it  
Tel: +33 7 72 36 58 84

\*As dimensões gerais dos modelos Dorelan são fornecidas apenas para fins informativos. Uma tolerância dimensional de 3 a 5% pode ser observada para todos os materiais que compreendem têxteis e estofamento

# BUNK BEDS AND GUEST BEDS



A Hotelys é uma subsidiária da Ouest Bedding, dedicada exclusivamente a estabelecimentos hoteleiros, com a mais vasta gama de camas do mercado. A Hotelys também oferece produtos para todos os tipos de estabelecimentos, domínio de todas as tecnologias do mercado, uma escolha incomparável de acabamentos/modelos e uma organização totalmente dedicada à indústria hoteleira.

## Kangourou model



### PROPERTIES

- Chaise longue com cama extra integrada com encosto
- Colchão de espuma de poliuretano HD 35kg/m<sup>3</sup>
- Garantia de 5 anos (colchão), 2 anos (mecânica)



### DIMENSIONS

ALTURA 36 PROFUNDIDADE 90  
LARGURA 200

Score EcoVadis

66/100



- Grande variedade de cores
- Cama pronta
- Revestimento retardador de chamas



### CONTACT

FRANCE/EUROPE

Gaetane le Dru

[gledru@adova-group.com](mailto:gledru@adova-group.com)

Tel (0)6 03 85 95 73

A STORE

A Hotelys é uma subsidiária da Ouest Bedding, dedicada exclusivamente a estabelecimentos hoteleiros, com a mais vasta gama de camas do mercado. A Hotelys também oferece produtos para todos os tipos de estabelecimentos, domínio de todas as tecnologias do mercado, uma escolha incomparável de acabamentos/modelos e uma organização totalmente dedicada à indústria hoteleira.

## Gigogne model:



### PROPERTIES

- Cama auxiliar que pode ser posicionada sob a cama principal
- Colchão de espuma de poliuretano HD 35kg/m<sup>3</sup>
- Garantia de 5 anos (colchão), 2 anos (mecânica)



### DIMENSIONS

- C198x LARGURA 80 x ALTURA 36

Score EcoVadis  
66/100



Armazenamento sem  
bagunça  
Armazenamento rápido  
Colchão com tecido  
retardador de fogo



## CONTACT

FRANCE/EUROPE

Gaetane le Dru  
[gledru@adova-group.com](mailto:gledru@adova-group.com)

Tel (0)6 03 85 95 73

ASTORE

# ADOVA extra beds (*Hotelys*)



ADOVA  
GROUP

A Hotelys é uma subsidiária da Ouest Bedding, dedicada exclusivamente a estabelecimentos hoteleiros, com a mais vasta gama de camas do mercado. A Hotelys também oferece produtos para todos os tipos de estabelecimentos, domínio de todas as tecnologias do mercado, uma escolha incomparável de acabamentos/modelos e uma organização totalmente dedicada à indústria hoteleira.

## Versatile bed model



### PROPERTIES

- Cama extra vertical sobre rodízios
- Colchão de espuma de poliuretano HD 35kg/m<sup>3</sup>
- Garantia de 5 anos (colchão), 2 anos (peças mecânicas)



### DIMENSIONS

- Dimensões totais: 80X190, desdobrado  
ALTURA 36 CM



Score EcoVadis

66/100



- Capa de armazenamento
- Cama pronta
- Revestimento à prova de fogo



### CONTACT

FRANCE/EUROPE

Gaetane le Dru

[gledru@adova-group.com](mailto:gledru@adova-group.com)

Tel (0)6 03 85 95 73

Website:

<http://www.hotelys.com/fr/>

# ADOVA extra beds (*Hotelys*)



ADOVA  
GROUP

A Hotelys é uma subsidiária da Ouest Bedding, dedicada exclusivamente a estabelecimentos hoteleiros, com a mais vasta gama de camas do mercado. A Hotelys também oferece produtos para todos os tipos de estabelecimentos, domínio de todas as tecnologias do mercado, uma escolha incomparável de acabamentos/modelos e uma organização totalmente dedicada à indústria hoteleira.

## *Baby bed model*



### PROPERTIES

- Berço
- Colchão de espuma de poliuretano, altura 14 cm
- Garantia de 5 anos (colchão), 2 anos (peças mecânicas)



### DIMENSIONS

- Dimensões desdobrado: 120 cm de comprimento x 60 cm de largura x 77 cm de altura

Score EcoVadis  
66/100



- Conforto excepcional para bebés
- Revestimento resistente ao fogo



Zoom sur :



Charnière d'angle



Charnière de pliage



Roues avec frein



**CONTACT**

FRANCE/EUROPE

Gaetane le Dru

[gledru@adova-group.com](mailto:gledru@adova-group.com)

Tel (0)6 03 85 95 73

# DORELAN bunk beds

ASTORE



dorelan®  
dormire bene vivere meglio

A DORELAN, fabricante líder de roupa de cama e sofás-cama da Itália, foi fundada em Forli em 1968

## ASTUCIO model



### PROPERTIES

- Espessura do colchão 15cm
- Garantia de 24 meses
- Densidade 45 kg/m<sup>3</sup>
- Sistema Easyflip®:
- Fácil inversão do assento



### DIMENSIONS

- 222 x 99 x 100/156 cm aprox.
- Altura do assento: H47 cm aprox

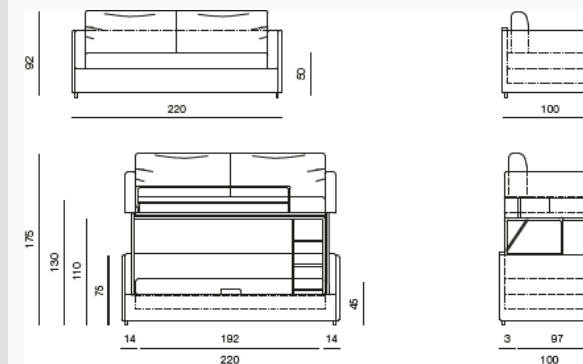

### Score EcoVadis

68/100



\*O tamanho "geral" dos modelos Dorelan é apenas para informação. Uma tolerância dimensional de 3 a 5% para todos os materiais que compreendem têxteis e materiais estofados pode ser observada.



- Tecido do cliente possível
- Removível
- Sistema Easyflip®
- 160 revestimentos e cores disponíveis



- Sem alça
- Sem cama pré-montada
- Sem espaço de armazenamento

## CONTACT

FRANCE/EUROPE

Mirko de Lucia  
m.delucia@dorelan.it

Tel: +33 7 72 36 58 84

ASTORE

# DORELAN guest beds



dorelan®  
dormire bene vivere meglio

A DORELAN, fabricante líder de roupa de cama e sofás-cama da Itália, foi fundada em Forlì em 1968

## Vertical guest bed model



### PROPERTIES

- Estrado de ripas com cintas verticais
- Opção de capa de sommier com pregas



### DIMENSIONS

Dimensões totais: 92 x 210 cm



Score EcoVadis  
68/100



\*O tamanho "geral" dos modelos Dorelan é apenas para informação. Uma tolerância dimensional de 3 a 5% para todos os materiais que compreendem têxteis e materiais estofados pode ser observada.

- Tecido do cliente possível
- Removível
- 160 revestimentos e cores disponíveis



- Sem alça
- Sem cama pré-montada
- Sem espaço de armazenamento



## CONTACT

FRANCE/EUROPE

Mirko de Lucia  
m.delucia@dorelan.it  
Tel: +33 7 72 36 58 84

A DORELAN, fabricante líder de roupa de cama e sofás-cama da Itália, foi fundada em Forli em 1968

## CHERIE F7 BUNK model



### PROPERTIES

- Espessura 15cm
- Garantia de 24 meses
- Densidade 45 kg/m3



### DIMENSIONS

210 x 100cm  
Altura do assento: 45cm



\*O tamanho "geral" dos modelos Dorelan é apenas para informação. Uma tolerância dimensional de 3 a 5% para todos os materiais que compreendem têxteis e materiais estofados pode ser observada.

Score EcoVadis

68/100



- Tecido do cliente possível
- Removível



- Sem alça
- Sem cama pré-montada
- Sem espaço de armazenamento

## CONTACT

FRANCE/EUROPE

Mirko de Lucia  
m.delucia@dorelan.it

Tel: +33 7 72 36 58 84

# DAYBEDS





BK Group é uma empresa italiana que tem se especializado na produção de sofás e poltronas conversíveis há 60 anos.

## BK 113 model



### PROPERTIES

- Espuma HR 40 kg/m<sup>3</sup>
- Garantia de 2 anos
- Densidade: 40 kg/m<sup>3</sup>
- Espessura: 15 cm

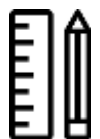

### DIMENSIONS

- L202 x P90 cm
- Altura do assento: 47 cm

**Score EcoVadis**  
43/100



- Tela del cliente disponible
- Cama preinstalada
- Espuma ignífuga



Sem correia



### CONTACT

FRANCE/EUROPE

Sara Mandelli  
[sara@bkitalia.com](mailto:sara@bkitalia.com)  
Tel: + 39 03 63 48 971

**A**STORE

DORELAN, o principal fabricante italiano de roupa de cama e sofás conversíveis, foi fundado em Forlì em 1968.

## Cherie S UP model



### PROPERTIES

- Densidade: 45 kg/m<sup>3</sup>
- Espessura: 15 ou 20 cm
- Garantia de 4 meses
- Sistema Easyflip®: fácil de virar o assento



### DIMENSIONS

- A partir de L190 x P90 cm
- Altura do assento: 46 cm

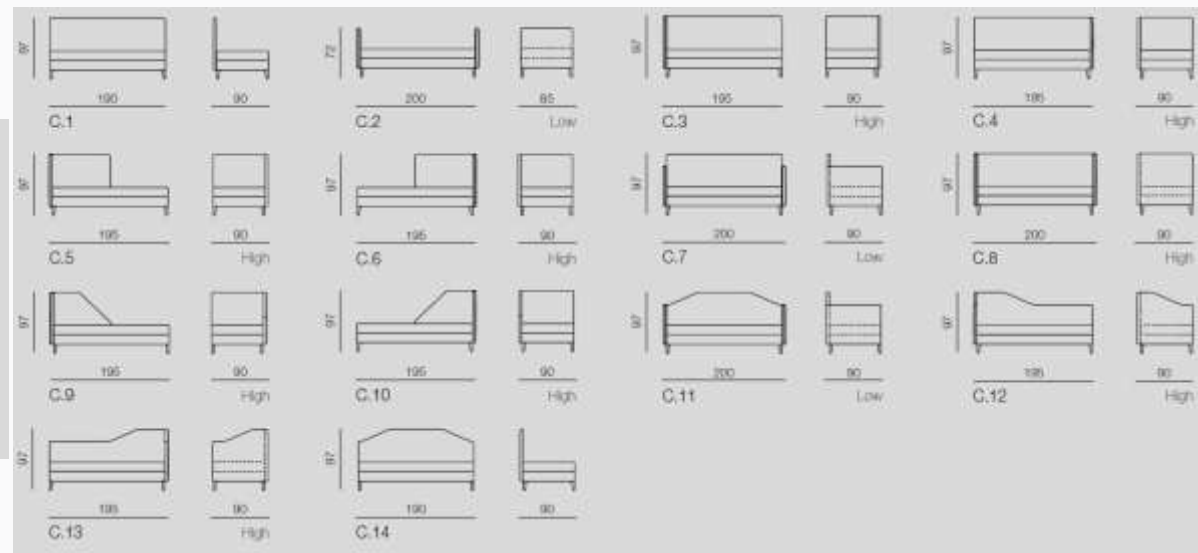

Score EcoVadis

68/100



- Tecido do cliente disponível
- Espuma retardante de fogo
- Tecido do cliente disponível
- Espuma retardante de fogo
- 160 revestimentos e cores disponíveis



- Sem correia
- Sem espaço de armazenamento



### CONTACT

FRANCE/EUROPE

Mirko de Lucia

m.delucia@dorelan.it

Tel: +33 7 72 36 58 84

ASTORE

As dimensões «totais» dos modelos Dorelan são fornecidas apenas para informação. Pode ocorrer uma tolerância dimensional de 3 a 5 % em todos os materiais que incluem tecidos e materiais acolchoados.

DORELAN, o principal fabricante italiano de roupa de cama e sofás conversíveis, foi fundado em Forlì em 1968

## Cherie M10 UP model



### PROPERTIES

- Density 45 Kg/M3
- Thickness 15 or 20 cm
- 24-month guarantee
- Easyflip® system: easy turning of the seat



### DIMENSIONS

- L 200x D95 cm
- Seat height: 42cm

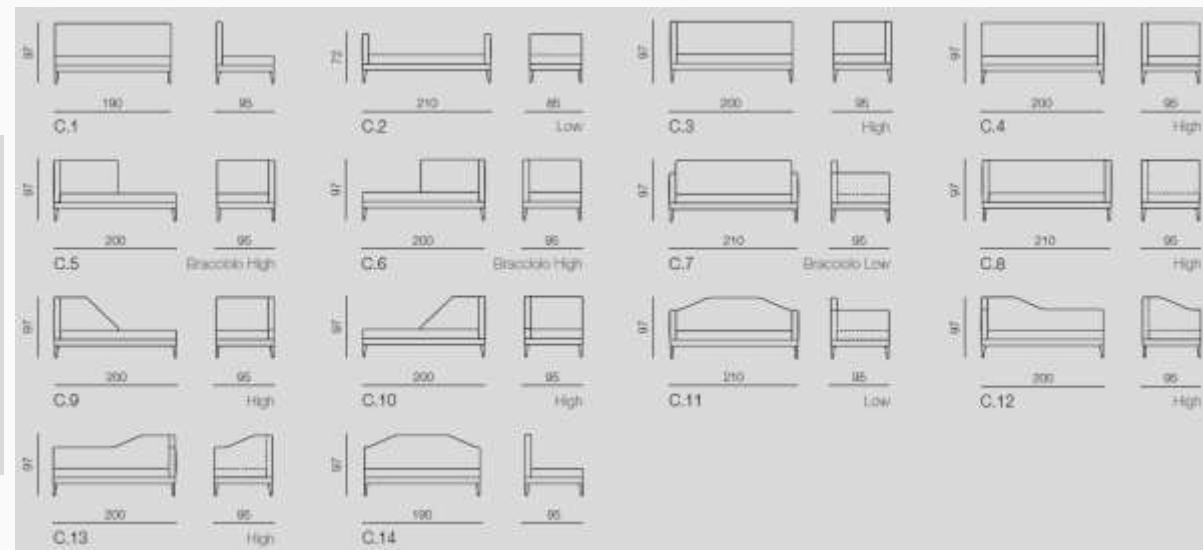

Score EcoVadis

68/100



- Tecido do cliente disponível
- Espuma retardante de fogo
- Tecido do cliente disponível
- Espuma retardante de fogo

• 160 revestimentos e cores disponíveis



- Sem correia
- Sem espaço de armazenamento
- Sem cama pré-montada



### CONTACT

FRANCE/EUROPE

Mirko de Lucia

m.delucia@dorelan.it

Tel: +33 7 72 36 58 84

ASTORE

\*The 'overall' dimensions of Dorelan models are given for information only. A dimensional tolerance of 3 to 5% may be observed for all materials comprising textile and padded materials.

DORELAN, o principal fabricante italiano de roupa de cama e sofás conversíveis, foi fundado em Forlì em 1968

## Dana UP model



### PROPERTIES

- Density 45 Kg/M3
- Thickness 15 or 20 cm
- 24-month guarantee
- Easyflip® system: easy turning of the seat

### DIMENSIONS



- From L200 x D93 cm
- Seat height: 45cm

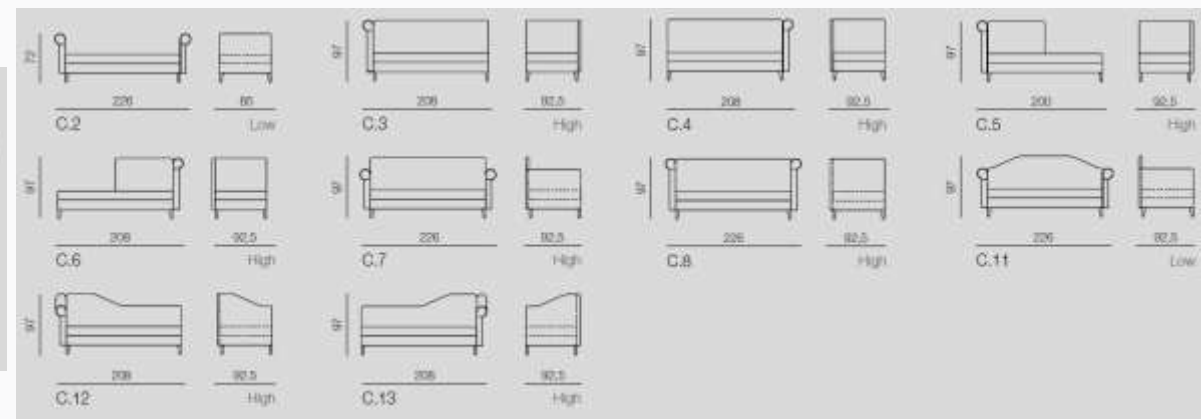

Score EcoVadis

68/100



\*The 'overall' dimensions of Dorelan models are given for information only. A dimensional tolerance of 3 to 5% may be observed for all materials comprising textile and padded materials.



- Tecido do cliente disponível
- Espuma retardante de fogo
- Tecido do cliente disponível
- Espuma retardante de fogo
- 160 revestimentos e cores disponíveis



- Sem correia
- Sem espaço de armazenamento



## CONTACT

FRANCE/EUROPE

Mirko de Lucia  
m.delucia@dorelan.it  
Tel: +33 7 72 36 58 84  
**ASTORE**

Como o principal varejista online da Europa de móveis, iluminação e artigos para casa de design, a gama de produtos da Made In Design inclui marcas de topo (Kartell, Hay, Foscarini, etc.) e designers renomados (Starck, Dixon)

## Model day Bed - CLASSICON



### PROPERTIES

- Densidade: 35 kg/m<sup>3</sup>
- Garantia: 24 meses
- Despesas de envio e embalagem
- Espessura: 14 cm



### DIMENSIONS

- L190 x P86
- Altura do assento: 38 cm



Score EcoVadis  
52/100



- Tecido do cliente disponível
- Correia para o assento



- Sem espaço de armazenamento
- Sem cama pré-montada
- Sem capas removíveis



### CONTACT

FRANCE/EUROPE

LASSALLE Charlène

[charlene.lassalle@madeindesign.com](mailto:charlene.lassalle@madeindesign.com)

+33 (0)4.38.12.34.75

ASTORE

Fundada em 1982, a SOCA fabrica móveis de design contemporâneo sob medida para profissionais da hotelaria. A SOCA possui 3 áreas principais de especialização: criação de produtos de design e sob medida, estofamento e tapeçaria.

## RENOVO MODEL



### PROPERTIES

- Structure in wood and derivatives
- 100% cotton fitted sheet
- Polyurethane foam (50KG/m<sup>3</sup>)



### DIMENSIONS

- Estrutura em madeira e derivados
- Lençol ajustável 100 % algodão
- Espuma de poliuretano (50 kg/m<sup>3</sup>)

Score EcoVadis  
53/100



- Estrutura em madeira e derivados
- Lençol ajustável 100 % algodão
- Espuma de poliuretano (50 kg/m<sup>3</sup>)



- Sem espaço de armazenamento



### CONTACT

FRANCE/EUROPE

Jacques de Mascureau  
[j.de.mascureau@soca.fr](mailto:j.de.mascureau@soca.fr)  
Tel: + 33 2 40 68 85 10

# CONVERTIBLE OTTOMANS



BK Group é uma empresa italiana que tem se especializado na produção de sofás e poltronas conversíveis há 60 anos

## BK 116 model



### PROPERTIES

- Espuma HR 40 kg/m<sup>3</sup>
- Garantia de 2 anos
- Custos de envio: a serem quantificados
- Espessura: 13 cm
- Estrado com ripas de madeira
- Colchão de molas (15 cm de altura)



### DIMENSIONS

- L94 x P96 cm
- Altura do assento: 44/45 cm

Score EcoVadis  
43/100



- Tela del cliente disponible
- Cama preinstalada
- Espuma ignífuga



Sem correia



### CONTACT

FRANCE/EUROPE

Sara Mandelli  
[sara@bkitalia.com](mailto:sara@bkitalia.com)  
Tel: + 39 03 63 48 971

ASTORE

DORELAN, o líder italiano no setor de roupa de cama e sofás-cama, foi fundado em Forlì em 1968.

## GHOST model



### PROPERTIES

- Thickness 10cm
- 24 Month guarantee



### DIMENSIONS

- 75x 65x 50 cm
- Seat height: 37cm



- Tecido do cliente disponível
- Espuma retardante de fogo



- Sin correa
- Sin espacio de almacenamiento

- Tecido do cliente disponível
- Espuma retardante de fogo

- 160 revestimentos e cores disponíveis

Score EcoVadis  
68/100



## CONTACT

FRANCE/EUROPE

Mirko de Lucia  
m.delucia@dorelan.it

Tel: +33 7 72 36 58 84

## TEXTILE & CONFECTION



*Negócio francês e familiar há 300 anos.  
Especialista em soluções têxteis à medida para os segmentos Economy – gama média – hotéis de luxo.*



Economia – Gama Média – Luxo

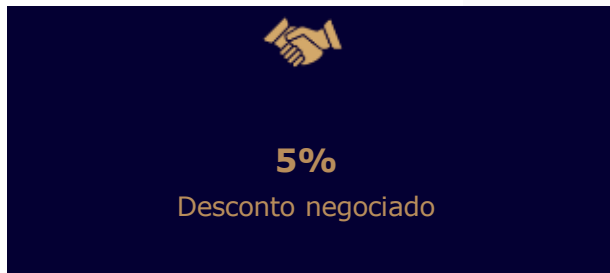

## DISTRIBUIÇÃO

- Varões para cortinas
- Cortinas transparentes
- Cortinas
- Almofadas
- Lanços
- Colchas
- Capas de cama
- Cortinas



## RSE

- Coleção fabricada em poliéster reciclado
- Reciclagem de tecidos em fim de vida
- Gestão responsável dos resíduos

## Certificações



**Pontuação  
EcoVadis**



## SERVIÇOS

Tecidos para decoração  
Alfaiataria com cortinas  
RideinOds, alfaiataria à medida

Serviços adicionais  
• Serviços de auditoria e instalação técnica

## Production

- 2 ateliers France et Europe

## Showroom:

- Voiron, Boulogne, Carros, Antilles

**Contacto:**

Vincent DE FALCO

Telefone +33 6 85 71 40 55

E-mail: [vincent.defalco@denantes.fr](mailto:vincent.defalco@denantes.fr)



<https://www.denantes.fr/catalogs>

Escritório: +33 (0)4 72 47 17 17

**PAÍSES COBERTOS: TODA A EUROPA E O NORTE DE ÁFRICA\*\*exceto Ucrânia, Geórgia, Macedónia do Norte, Roménia, Rússia, Arménia, Azerbaijão, Cazaquistão, Quirguistão e Usbequistão**

**DENANTES**  
1723

A Sotexpro é um fabricante francês de tecidos decorativos para estofos não inflamáveis desde 1973 e é o especialista indiscutível em tecidos ignífugos M1 e blackout. O desenvolvimento das suas coleções combina tanto a decoração como a técnica. Desde o fio até à produção de produtos acabados à medida, a Sotexpro integra todo o know-how necessário para o desenvolvimento dos seus projetos têxteis: impressão digital, tecelagem jacquard, personalização. A sua influência é agora internacional.



Tecidos M1 ignífugos



Prémios mencionados pelo Accor Toolkit

Desconto baseado no projeto

### RSE

Materiais reciclados ✓

Programa Second Life ✗

Concepção ecológica ✓

### Serviços

À medida ✓

Catálogo de produtos ✓

**Produção:** Sim

**Origem:** Sim

**Retomar serviço:** Não

### Certificações



**Pontuação EcoVadis**  
60/100



### O que é a norma de segurança contra incêndios M1?

A reação ao fogo de um material, definida em França pelo Decreto de 21 de novembro de 2002, avalia a sua capacidade de alimentar um incêndio (combustibilidade e inflamabilidade). Nos estabelecimentos abertos ao público (ERP), as cortinas, enquanto materiais de decoração, devem respeitar rigorosas normas de reação ao fogo. A classificação exigida para estes materiais é M1, de acordo com a norma NF P 92-507. Esta classificação, que dá direito ao titular a um relatório quinquenal, só pode ser atribuída por um laboratório francês aprovado pelo Ministério do Interior. **Na SOTEXPRO, todos os tecidos são testados para obter esta certificação obrigatória.**



### Contacto:

Catherine JACOB  
Tel.: +33 6 80 20 99 78  
E-mail: [cjacob@etoffes-inspire.fr](mailto:cjacob@etoffes-inspire.fr)



<https://sotexpro.fr/en/>

Escritório: 510 route de Montchal 42360 Panissières



## FITNESS & SPA EQUIPMENT

# CODE

A C.O.D.E. ChillOut Design Evolution, com sede em França, é especializada na conceção e fabrico de camas de massagem de alta qualidade e mobiliário personalizado dedicado a ambientes profissionais e privados de bem-estar, relaxamento e beleza. O conceito C.O.D.E. oferece produtos únicos em termos de design personalizável, conforto superior e funcionalidade de alto desempenho.

**-10 a -15%**  
em camas



**-20 a 30%**  
em opções

**5 anos** de garantia nos motores

## RSE

Materiais reciclados ✓

Programa de segunda vida ✓

Conceção ecológica ✓

## Serviços

Personalizados ✗

Personalização do produto ✓

**Produção:** Itália

 <https://www.code-spa.design/en/>

## Contacto:

Angelica MARAN  
[am@code-spa.design](mailto:am@code-spa.design)  
+(39) 3480466508

## Presença nos conceitos ACCOR

*Orient Express La Minerva, Roma (Itália)*

*MGallery Domaine de la Reine Margot, Issy-les-Moulineaux (França)*

*Mama Shelter Dubai (EAU)*

*Mondrian Les Carmes, Bordéus (França)*



Médio - Premium - Luxo - Estilo de vida



**CODE**  
CHILL OUT DESIGN EVOLUTION  
Luxury spa furniture

**ASTORE**

# Gharieni

30 anos de inovação e engenharia alemã são os pilares da marca global premium do Grupo Gharieni, conhecida pelas suas tecnologias de bem-estar comprovadas para a mente e o corpo e pelos equipamentos médicos, de spa e de bem-estar da mais alta qualidade.



Premium – Luxo – Estilo de vida

**-20 a 30%** sobre os preços públicos

**Garantia:**

- **10 anos para** peças metálicas e estruturas
- **5 anos para** motores
- **3 anos para** outras peças

## Presença nos conceitos ACCOR

Faimont Montreux Palace (Suíça)  
 Sofitel Frankfurt Opera (Alemanha)  
 Sofitel Dubai The Obelisk (Emirados Árabes Unidos)  
 Hotel Molitor – MGallery Collection, Paris (França)

### RSE

- ✓ Materiais reciclados
- ✓ Programa de segunda vida
- ✓ Conceção ecológica

### Serviços

- ✗ Feito à medida
- ✓ Personalização do produto

**Produção:** Alemanha

**Certificações:**  
 ISO 13485

 <https://www.gharieni.com/>

**Pontuação  
 EcoVadis**



### Contacto:

Aurore HADDOU  
[a.haddou@gharieni.com](mailto:a.haddou@gharieni.com)  
 +33 6 42 14 79 95



ASTORE

# Lemi

Era o início da década de 1990 e novos conceitos de bem-estar estavam a ser combinados com um espírito de criatividade, iniciativa e paixão pelo design, transformando assim o sonho numa empresa de grande alcance. A empresa é reconhecida pelo seu design excecional, investigação, tecnologia, qualidade, funcionalidade e acabamentos meticulosos.



**-30%** sobre os preços públicos

Até 10 anos de garantia  
e assistência **vitalícia**

## RSE

Materiais reciclados ✓

Programa de segunda vida ✓

Conceção ecológica ✓

## Serviços

Feito à medida ✗

Personalização do produto ✓

**Produção:** Itália

Certificações



 <https://www.lemispa.com/en/>

## Contacto:

Elena Bazzocchi  
[elena.bazzocchi@lemigroup.it](mailto:elena.bazzocchi@lemigroup.it)  
+39 335 7742393

## Presença nos conceitos ACCOR

Faimont Windsor Park, Englefield Green (Reino Unido)  
SO/ Sotogrande (Espanha)



Premium – Luxo – Estilo de vida

**Lemi**  
ITALIAN WELLNESS EQUIPMENT™

ASTORE

# Life Fitness

«A Life Fitness compreende as necessidades tanto dos hotéis independentes como das cadeias internacionais.  
Ajudam a definir os padrões da marca das instalações de fitness, a diferenciá-lo da concorrência e a aumentar a satisfação do cliente ao longo do processo.»



Cerca de **-50%** sobre os preços públicos (Preços EXW)

**Garantia de 2 anos** para todos os produtos

**Garantia de 10 anos** para a estrutura de todos os produtos de resistência fabricados

## Recomendação por gama de hotéis:



Activate cardio, Axiom Resistance & Racks



Integrity cardio, Insignia Resistance & Racks



Elevation – Discover cardio, Synergy Resistance & Hammer Strength

**Produção:** Europa, Ásia

## Serviços

Experiência virtual, nuvem, treinador digital, ecrã HD...

Especialista em design de instalação

## Pontuação EcoVadis

39/100

## Contacto:

Richard Burden  
[Richard.Burden@lifefitness.com](mailto:Richard.Burden@lifefitness.com)



<https://www.lifefitnessemea.com/en-eu>



Gama Económica – Média – Premium



 **LIFEFITNESS**  
FAMILY OF BRANDS

**ASTORE**

# Matrix

“A Matrix entende que o fitness faz parte de uma ideia cada vez mais holística de bem-estar que influencia todo o tipo de decisões relacionadas ao estilo de vida, incluindo onde ficar durante uma viagem. O fitness tornou-se uma expectativa; a Matrix pode ajudá-lo a transformá-lo numa experiência!”

 Gama Eco - Média – Premium – Luxo - Estilo de vida

  
**Cerca de -40%**  
Sobre os preços públicos ( Preços FOB )  
**3 anos**  
Garantia de peças e mão de obra



## Recomendação por gama de hotéis:



Série Lifestyle cardio com série Go strength ou série Versa strength



Série cardio de resistência com série de força Versa plus



Série cardio Performance com série Ultra Strength e consolas de treino inteligentes

## Serviços

Feito sob medida X

Personalização do produto X

**Produção:** Europa, Ásia

**Pontuação EcoVadis**  
39/100

## Contacto:

Gary YOUNG  
[gary.young@jhtgroup.uk](mailto:gary.young@jhtgroup.uk)  
+44 (0) 7974 115 897

 <https://www.matrixfitness.com/en>

**MATRIX**  
Strong • Smart • Beautiful

**ASTORE**

# PBI - Probeautic Institut

O PBI - Probeautic Institut é um especialista reconhecido em produtos de beleza profissionais desde a sua criação em 1997. Como fabricante e grossista especializado em equipamentos para profissionais de beleza, com mais de 6000 referências, oferecemos uma vasta gama de produtos e marcas profissionais para venda.



**-10%** sobre os preços de catálogo  
Condições especiais para projetos de construção ou renovação.

Garantia **de 1 a 2 anos**

## Presença nos conceitos ACCOR

MGallery Les Cures Marines, Trouville (França)  
MGallery Cabot, Bordéus (França)  
Novotel Avignon Centre (França)



Médio segmento - Premium - Luxo -  
Estilo de vida

### RSE

Materiais reciclados ✓

Programa de segunda vida ✓

Conceção ecológica ✓

### Serviços

Personalizados ✗

Personalização do produto ✗



EQUIPAMENTO DE SPA



EQUIPAMENTO DE  
MANICURE E PEDICURE



AMBIENTE E DECORAÇÃO DE  
SPA



BOUTIQUE DE VENDAS A RETALHO DO SPA



WELL TECH



MASSAGEM E CUIDADOS  
COM A PELE



ROUPA DE CAMA DESCARTÁVEL  
E VESTUÁRIO



ROUPA DE SPA, LENÇÓIS,  
COBERTORES  
E UNIFORMES



HIGIENIZAÇÃO E LIMPEZA



DEPILAÇÃO

### Âmbito de distribuição:

França e Dom-Tom, Mónaco,  
Andorra, Suíça, Europa,  
Médio Oriente, Norte de  
África

### Certificações:

- Membro da SPA-A
- Classificação Ethifinance
- Patrocinador Pure Océan
- Membro Citeo
- Membro da ÉcoSystem

### Contacto:

Mohamed ARAII  
[mohamed.araii@pbifrance.com](mailto:mohamed.araii@pbifrance.com)  
+33 (0) 634 240 722



<https://www.probeauticinstitut.com/>

**pbi**  
probeautic institut

ESTHÉTIQUE | SPA | WELLNESS

**ASTORE**

# Precor

Equipe o seu ginásio com soluções de fitness preferidas e confiáveis por praticantes, treinadores e operadores de instalações em mais de 100 países.

  
**45%** Percentagem de desconto sobre o preço de retalho

**2 anos, 10 anos de** garantia **para as armações**

## RSE

Materiais reciclados ✓

Programa de segunda vida ✗

Conceção ecológica ✗

## Serviços

Personalizados ✗

Personalização do produto ✗

**Produção:** Europa, Ásia

**Pontuação EcoVadis**

58/100



## Contacto:

Nikki Doolan  
[Nikki.doolan@precor.com](mailto:Nikki.doolan@precor.com)  
+44 (0) 744 308 30 62



<https://www.precor.com/>



Gama Eco - Média gama - Premium



**PRECOR**

ASTORE

# Technogym

«A oferta principal da empresa é o Technogym Ecosystem, composto por equipamentos inteligentes para treino cardiovascular, treino de força e treino funcional, juntamente com a plataforma de rede mais avançada e uma gama completa de serviços.»

**-10% a -35%**

Sobre os preços públicos (preços EXW)  
Garantia de **2 anos** (peças sobressalentes) e **1 ano** (mão de obra)

## Recomendação por gama de hotéis:



Cardio, Excite Live 500 700 900 /  
Força, Selection 700



Cardio, Excite Live 5000 7000  
9000 / Força, Selection 900



Cardio e Força, Artis Line

**Produção:** Europa, Itália, Ásia

## Contacto:

Camilla Menegazzo -  
[cmenegazzo@technogym.com](mailto:cmenegazzo@technogym.com)

## Serviços

Serviços de design de interiores da Technogym

Solução de bem-estar total: equipamentos inteligentes conectados, soluções digitais, programas e educação, serviços financeiros...

## Certificações

142 patentes internacionais e mais de 93 marcas registadas

**Pontuação EcoVadis**

84/100



<https://www.technogym.com/>



Gama Média – Premium – Luxo – Estilo de vida



**TECHNOGYM**

ASTORE

**ASTORE**

YOUR PROCUREMENT PARTNER

**ASTORE**