



ASTORE

YOUR PROCUREMENT PARTNER



This is a strictly confidential support only to be used by Astore clients



This catalogue is updated every quarter to provide the latest information



For any further information or support please contact your local Astore team



All information can be found in the Supplier section on [Astoreprocurement.com](https://www.astoreprocurement.com)

SUPPLIER DIRECTORY

Preface



PORTUGAL NOMINATED SUPPLIERS

FF&E



ASTORE ENA – NOMINATED SUPPLIERS – PORTUGAL

ASTORE



Furniture & Design

BEDDING

INDOOR, OUTDOOR & OFFICE FURNITURE

LIGHTING

SOFA BEDS

SPA & FITNESS EQUIPMENT

List of Nominated Suppliers

PORTUGAL



BEDDING



ADOVA

Fabricante de camas (colchões, estrados, sobrecolchões). Colchões Tréca e Simmons, bases de cama, cabeceiras, camas extra... fabricados na nossa unidade de produção em Fougères, França, e entregues em todo o mundo. Os produtos Hotelys proporcionarão aos seus hóspedes noites inesquecíveis.



Preços e condições

Disponíveis em astoreprocurement.com

RSE

Materiais reciclados ✓

Design ecológico ✓

Países de fabrico:

França, fornecendo para a Europa e Norte de África (exceto Reino Unido e Itália)

CONTACTO

Apenas França:

Gaetane LE DRU

gledru@adova-group.com

+33 6 03 85 95 73

Todos os outros países:

Jacqueline BERGER

jberger@adova-group.com

+33 6 27 64 04 60

SERVIÇOS

Transporte ✓

Instalação ✓

Gestão de produtos antigos ✓

Certificações



EcoVadis



TRECA
PARIS



Eco, Midscale e Premium*

*Exceto Swissôtel

HOTELYS

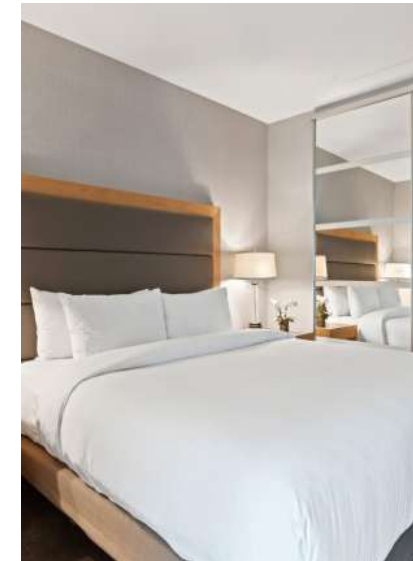

<https://www.hotelys.com/en/>

ADOVA
GROUP

ASTORE

ATL PRODUCTION

A ATL é especializada no fabrico de estruturas metálicas e oferece uma gama ampla e diversificada de produtos. A ATL oferece **beliches e mobiliário** para hotéis económicos, **estantes** para áreas de serviço (lavandaria, armazenamento de bagagem, etc.), **Levly**, sistema de elevação de camas



Preços e condições

Disponível em astoreprocurement.com

CSR

Materiais reciclados	✓
Programa de segunda vida	✓
Eco design	✓

Serviços

Madeira	✓
Metal	✓
Instalação	✓
Feito à medida	✓
Quarto	✓
Serviços gerais	✓

Instalação interna

Produção: 34 Rue Jean Jaurès
23200 Aubusson

Origem: EUROPA - FRANÇA

Certificações



Pontuação EcoVadis
51/100



Contacto:

Philippe de COURTILLES
contact@atlproduction.fr
Tel.: 05 55 66 34 00



Económico

Levly para todas as categorias de hotéis.

levly®



RAYONNAGE



ORÇAMENTO HOSPITALIDADE

Beliches e móveis

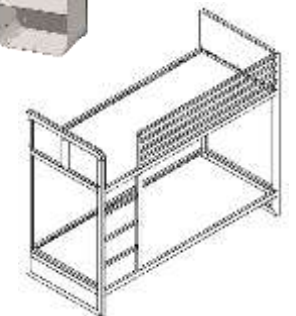

COFEL

O grupo COFEL é hoje líder no setor de roupa de cama na França e parceiro histórico da Accor desde 1988. Somos fornecedores nomeados das seguintes marcas da Accor: 25hours, Adagio, Hotel F1, Grand Mercure, Greet, Handwritten, Ibis, Ibis Styles, Ibis Budget, Jo&Joe, MGallery, Mama Shelter, Mercure, Movenpick, Novotel, Novotel Suites, Pullman, Sofitel, Tribe.

Com a vocação de contribuir para o bem-estar dos consumidores, melhorando a qualidade do seu sono, o Grupo está empenhado e inova constantemente para oferecer o melhor em roupa de cama com as suas 3 marcas muito conhecidas: Bultex, Merinos e Epeda.



Preços e condições

Disponível em astoreprocurement.com

RSE

Materiais reciclados ✓

Design ecológico ✓

Países de fabrico: França, fornecendo a Europa e o Norte de África (excluindo o Reino Unido)

Certificações



Pontuação EcoVadis

43/100



Serviços

Transporte ✓

Instalação ✓

Gestão de produtos antigos ✓



Eco, Midscale e Premium*

*Exceto Swissôtel



 <https://cofel.fr/>

CONTACTO

Para França

Mirko SANTI

santi.mirko@cofel.biz

+33969390425

Para todos os outros países:

Élise BAUER

bauer.elise@cofel.biz

+33(0)6 40 17 48 99 // +33141902846

Sede: 57 rue Yves Kermen. BOULOGNE-BILLANCOURT, 92100, França

Groupe
Cofel

ASTORE

FLEX

A Flex é uma marca espanhola icónica, cujo objetivo é melhorar a sua qualidade de vida através do descanso. Somos fornecedores nomeados das seguintes marcas: Ibis, Ibis Styles, Ibis Budget, Greet, Mercure, Novotel, Novotel Suites, Handwritten, Pullman, Movenpick, Grand Mercure, Tribe. País de fabrico: Portugal. Estamos focados na investigação e no design contínuos, os pilares em que nos baseamos para sermos líderes na indústria de roupa de cama.



Preços e condições

Disponível em astoreprocurement.com

RSE

- ✓ Materiais reciclados
- ✓ Conceção ecológica

Países de fabrico:

Portugal, fornecendo a Europa* e o Norte de África (exceto Reino Unido e Itália).

Contacto:

Mario SILVA
mario.silva@molaflex.com
+351 938 570 456

SERVIÇOS

- ✓ Transporte
- ✓ Instalação
- ✓ Gestão de produtos antigos

Certificações



<https://www.flex.es/hoteleria>

Eco, Midscale e Premium*

* Imagens não pertencentes à Accor; consulte os kits de ferramentas para conhecer os padrões da marca.

*Excluindo Swissôtel

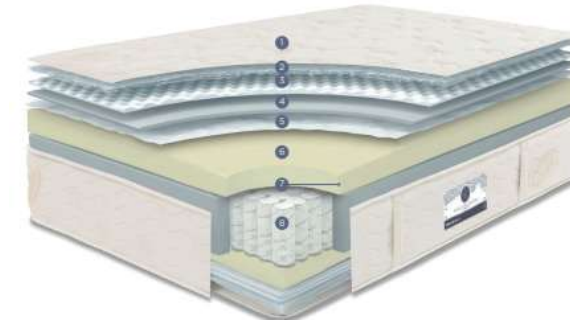

HEIGHT
34

Metal Noir
Hauteur: 15cm



HILDING ANDERS

A Hilding Anders, empresa líder global no setor de roupa de cama e colchões, tem-se empenhado em ajudar as pessoas a terem uma boa noite de sono. Temos orgulho em oferecer soluções de roupa de cama e sono para todas as necessidades e em ter algumas das marcas mais prestigiadas de roupa de cama e colchões no nosso portfólio: Carpe Diem Beds, Jensen, BICO e Slumberland.



Preços e condições

Disponível em astoreprocurement.com

CSR

Materiais reciclados ✓

Programa Second Life ✓

Serviços

Transporte ✓

Instalação ✓

Gestão de produtos antigos ✓

Fábrica: :Bélgica, Polónia, Espanha, Croácia e Itália

Fornecimento Europa e Norte de África

Certificações



Pontuação EcoVadis

67/100



Contacto internacional:

Els Braekman

els.braekman@hildinganders.com

+32 9 389 89 49

Contacto por país

Disponível em astoreprocurement.com



<https://www.hildinganders.com/>



Eco, Média gama e Premium

*Exceto Swissôtel

Sede: Hilding Anders AB Neptunigatan 1, Posthusplatsen 211 20 Malmö, Suécia

HILDING ANDERS

ASTORE

TEMPUR SEALY

A Tempur Sealy é líder mundial em design, fabrico, distribuição e venda a retalho de artigos de cama. Somos o fornecedor mundial nomeado para a Swissotel. Além disso, somos fornecedor nomeado no Médio Oriente, África e Pacífico para as seguintes marcas: Mercure, Novotel, Novotel Suites, Handwritten, Pullman, Movenpick, Grand Mercure, Tribe...



Preços e condições

Disponível em astoreprocurement.com

CSR

- ✓ Materiais reciclados
- ✓ Design ecológico

Serviços

- ✓ Transporte
- ✓ Instalação
- ✓ Gestão de produtos antigos

Fábrica: Grécia, Reino Unido, Turquia, Marrocos

Fornecimento: Europa, Reino Unido, Turquia e Norte de África

Certificações



Pontuação EcoVadis
29/100

Contacto:

Alexander Gifthaler

alexander.gifthaler@tempursealy.com

+393455818207



<https://www.tempursealy.com/>



Médio e Premium*

Apenas Swissôtel



TEMPUR+SEALY

Sede: Sede global 1000 Tempur Way Lexington, KY 40511

ASTORE

INDOOR, OUTDOOR & OFFICE FURNITURE





INDOOR FURNITURE

AGENCIA

ALMA SANCTURA

APIR

BK ITALIA

COLLINET

DORELAN

FERMOB

MADE IN DESIGN

MAISONS DU MONDE

MOUSSE DU NORD - HOME SPIRIT

NAP

PARLA DESIGN

RBC

RICHARD MOBILIER

LIGNE ROSET

RESISTUB

SERAX

SILTEC

SILVERA

SOCA

TABLE PLACE CHAIRS

VITRA

WIESNER HAGER

List of Nominated Suppliers

PORTUGAL

A Agencia Europe baseia-se, acima de tudo, nos valores humanos, em pessoas empenhadas que colocam os seus conhecimentos e experiência ao serviço dos clientes para apoiar os seus projetos com total transparência. Como especialista em ordenação do espaço, a Agencia Europe ouve-o e apoia-o, oferecendo-lhe um serviço de consultoria, design e soluções de mobiliário, bem como um serviço de gestão e instalação de FF&E e OS&E.

Eco-Midscale / Upscale

Entre un -26 % y un -40 %, dependiendo de la marca. Sobre los precios públicos sin IVA.

RSE

- Materials reciclados ✓
- Programa Second Life ✓
- Concepción ecológica ✓

Services

- Personalizado ✓
- Modificação dos produtos do catálogo ✓

Production: EUROPE

Recuperação de móveis?

Certifications



Eco Vadis Score

TBC

Contact :

Thierry CAMPOLUNGI
thierry.campolunghi@agenciagroupe.com
 Mobile : +33 6 26 30 99 99



<https://www.agenciagroupe.com/>



NOS PARTENAIRES
MOBILIERS
INTERIEUR



AGENCIAMEA
LA CONCEPTION DU BIEN-ÊTRE

A Alma Sanctura é um coletivo especializado em mobiliário contratado, que oferece soluções completas de mobiliário contratado individual e serviços de estofamento para os setores de hotelaria, restauração e promoção residencial. A Alma Sanctura representa um portfólio diversificado de marcas nacionais e internacionais. Como compromisso com a sustentabilidade, o programa ecoSanctura apoia o uso de móveis ecológicos entre os nossos parceiros.

-25% no folheto
Garantia de 1 a 15 anos contra defeitos de fabrico

RSE

Materiais reciclados

Programa Second Life

Concepção ecológica

Services

personalizado

Modificação dos produtos do catálogo

Production : Singapore, Malaysia, Indonesia, China & Belgium

Contact :

Vanessa LIM
sales@almasanctura.com
 +65 9625 3744



<https://www.almasanctura.com/>



Range Eco - Mid - Prem - Luxury - Lifestyle



ALMA
Sanctura



APIR

Apir é especializada no design e fabrico de sinalização e acessórios para hotéis desde 1918: suportes para malas, carrinhos de bagagem, cestos do lixo, cinzeiros, suportes para ementas, porta-guarda-chuvas e muito mais. O seu ponto forte é a produção de sinalização personalizada. Recentemente, adicionaram interruptores e tomadas personalizados à sua gama.

 Gama Eco-Midscale



CSR

- Materiais reciclados ✓
- Programa Segunda Vida ✗
- Conceção ecológica ✗

Serviços

- Personalizados ✓
- Modificação de produtos do catálogo ✓

Produção **ITÁLIA**

Origem **ITÁLIA**

Pontuação EcoVadis
30/100

Serviço de recolha de mobiliário: ✗



Contacto:

Lauriane COUTURIER
laurianec@apir.com Tel:+33
(0)6731178 63



[Website](#)



O Grupo BK é uma empresa italiana especializada na produção de sofás e poltronas convertíveis há 70 anos. Para mais detalhes sobre produtos específicos, consulte o folheto especializado em camas convertíveis..

-50%
Sobre os preços profissionais da BK

Range Eco-Midscale / Upscale

BK 132



BK 108



BK 153



BK 116



RSE

- Materialis reciclados ✓
- Programa Second Life X
- Concepción ecológica ✓

Services

- Personalizado ✓
- Modificação dos produtos do catálogo ✓

Production: ITALIE
Sourcing: ITALIE

Certifications

Class 1IM materials

Recuperación muebles? No

Score EcoVadis

43/100



Contact :

Sara MANDELLI
sara@bkitalia.com
Tel: +39 03 63 48 971
Fax: +39 03 63 45 917

For more information on suppliers of sofa beds, please refer to our book specialising in sofa beds and occasional beds.



A Collinet é uma das maiores empresas de mobiliário da França. Desde 1887, a Collinet combina know-how, qualidade e oferece mobiliário com linhas refinadas, que são simultaneamente modernas e tradicionais. .



-50%
Sobre as tarifas profissionais da Collinet

 Midscale to Premium range

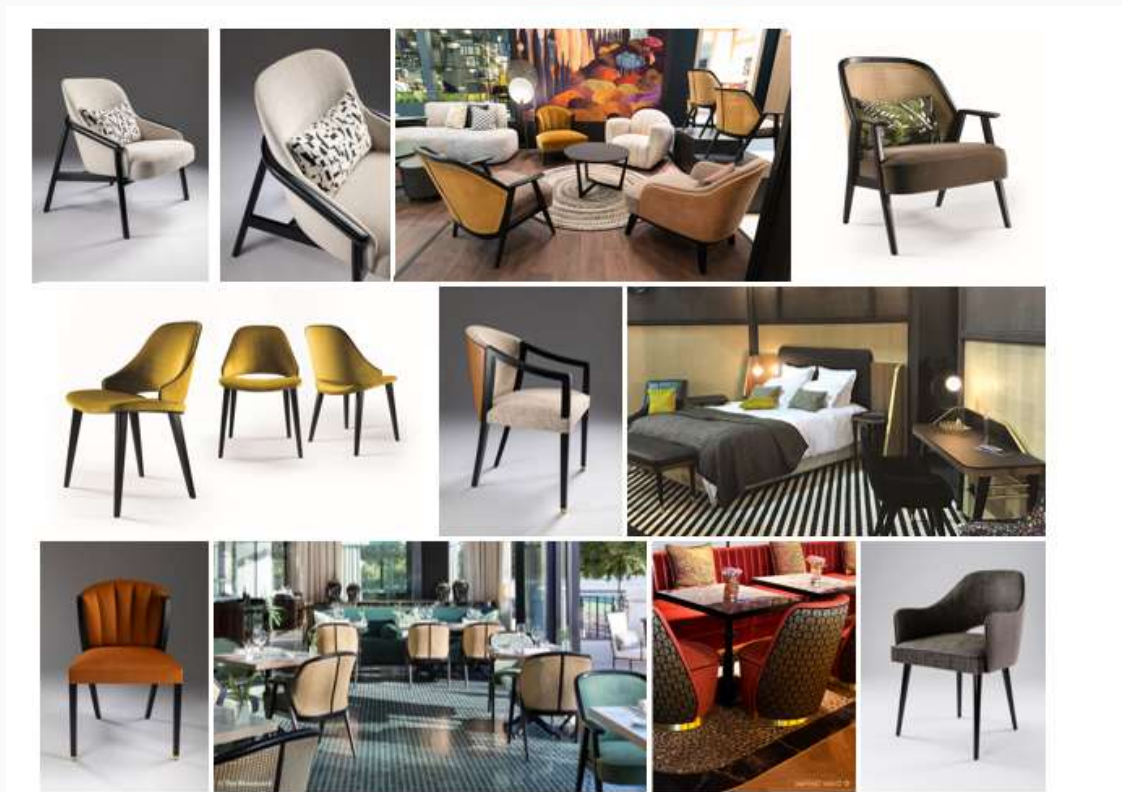

RSE

- Materials reciclados ✓
- Programa Second Life ✓
- Concepción ecológica ✓

Production_: FRANCE

Sourcing : FRANCE

Recuperación muebles? No

Services

- Personalizado ✓
- Modificación de productos del catálogo ✓

Certifications



EcoVadis Score

30/100

Contact :

Virginie COLLINET
virginie@collinet-sieges.fr
Tel: +33 6 85 71 84 84

 [Website](#)

A DORELAN, líder italiana no setor de sofás-cama e camas, foi criada em 1968.

Preços Accor negociados Enviados mediante solicitação

 Eco-Midscale Range

RSE

- Materialis reciclados X
- Programa Second Life ✓
- Concepción ecológica ✓

Services

- Personalizado ✓
- Modificación de productos del catálogo ✓

Production: ITALY

Sourcing: ITALY

Take-back service
No

Certifications



EcoVadis Score
68/100



 [Website](#)



For more information about suppliers of convertible sofa, please refer to our specific book about sofa bed.

 **Contact :**
 Mirko de Lucia
 m.delucia@dorelan.it
 _ Tel: +33 7 72 36 58 84

*Headoffice: Via Due Ponti N 9 47122 Forli Italiae
 Showroom: 6 Rue De Geneve 69804 - Saint Priest CEDEX FRANCE*



and a creator of colour in the garden, Fermob has become an expert in the overall design of outdoor spaces through a wide range of furniture, lighting and decorative accessories

35% off
the public prices excluding taxes

RSE

- Materiais reciclados e recicláveis
- Segunda vida programa
- Análise do ciclo de vida 100%
- Carbon Scan Accor
- Pintura renovação
- Retirada de móveis

Services

- Feito sob medida
- Bespoke



Certifications

- NF EN 581-1
- NF EN 1022
- NF EN 581-3
- NF EN 581-2

Score EcoVadis

68/100



[Fermob-contract.com](https://www.fermob-contract.com)

Production : France

Sourcing : France, Europe, Asie

Contact :

Agnes camacho
ACAMACHO@fermob.com
Mobile : +33 (0)6 89 01 39 24

Headoffice: Parc Actival 01140 Thoisy

Showroom Professionnels : 79 avenue Ledru Rollin 75012 PARIS
Neumarkt 49, 50667 Köln, ALLEMAGNE



Collection VALET BISTRO

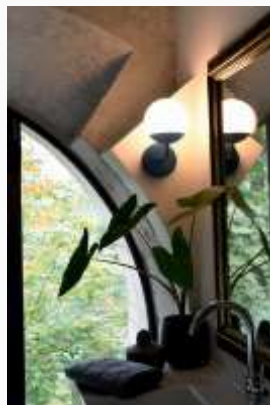

Collections MOON! PIAPOLO



Collection FACE A FACE



Collection BELLEVIE



Gamme Upscale



Collection FUNAMBULE, BE BOP



Collection CALVI, STUDIE, OTO

Como líder europeu no comércio online de mobiliário de design, iluminação e artigos para o lar, a Made In Design tem na sua gama algumas das maiores marcas (Hay, Foscarini, etc.) e designers de renome (Starck, Dixon, etc.).

-20% Sobre os preços públicos*
 Made in Design

 Range Premium



Services

Feito sob medida

Catálogo de produtos modificados

Score EcoVadis

52/100



Contact

Charlène LASSALLE
classalle@madeindesign.com
 Tel: +33 4 38 12 34 75

X
✓



Selection of their manufacturers : HAY | MUUTO | ETHNICRAFT | KARTELL | VITRA | POLS POTTEN | FATBOY | FLOS | ARTEMIDE | ASTRO LIGHTING | SANCAL | & TRADITION | NORMAN COPENHAGEN | GUBI

Office: 32 rue de Comboire - 38130 ECHIROLLES

*Prices expressed in EXW

made in design
 by PRINTEMPS

A Maisons du Monde é uma empresa francesa criada em 1996. É especializada no fabrico e distribuição de mobiliário e decoração para interiores e exteriores. Com a sua equipa integrada de designers, dispõe de uma vasta gama de produtos.



From -7% to -14%

Na Maisons du Monde, tarifas públicas para todas as encomendas superiores a 1000 €.

RSE

Materiais reciclados ✓

Programa Segunda Vida ✓

Concepção ecológica ✗

Production: FRANCE, ASIA, EUROPE

Sourcing : EUROPE

Serviço de recolha No

Services

Feito sob medida ✗

Pequenas modificações nos produtos do catálogo ✗

Certifications



EcoVadis Score

68/100



[Website](#)

Eco-Midscale Range



Contact :

Fabienne Sacareau
fsacareau@maisonsdumonde.com Tel: +33 6 08 54 05 52

MOUSSE DU NORD es un fabricante francés de sofás fijos o convertibles, sillones y sillas. Cuenta con una producción integrada (diseño, carpintería, corte y acolchado de espuma, montaje de sofás), lo que le permite suministrar productos a medida según las necesidades.

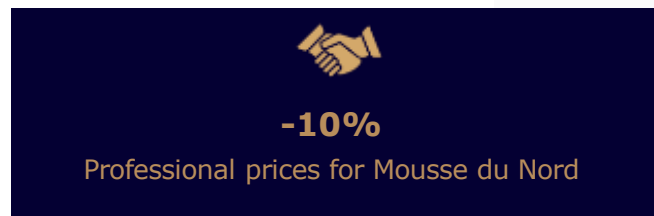

Range Eco-Midscale

RCS

Materiais reciclados ✓

Programa Segunda Vida ✓

Design ecológico ✓

Services

Feito à medida ✓

Modificação dos produtos do catálogo ✓

Production : FRANCE

Sourcing :FRANCE

Certifications



Score EcoVadis

49/100



Serviço de recolha de móveis SIM

Contact :

Eric Delpierre
edelpierre@homespirit.fr
 Tél 06 24 10 18 26



For more information on suppliers of sofa beds, please refer to our book specialising in sofa beds and occasional beds

A NAP é uma empresa polaca fundada em 2005, especializada no fabrico de mobiliário estofado. A empresa também produz mesas, cadeiras e bancos e distribui várias marcas líderes (Ethnicraft, Mullan, Jensen, etc.).

Range Midscale /Premium



RCS

Materiais reciclados

✗

Programa Segunda Vida

✓

Concepção ecológica

✗

Services

Feito sob medida

✓

Modificação dos produtos do catálogo

✓

Production : POLAND

Sourcing : EUROPE

Certifications

None

Serviço de recolha de móveis Não

Score EcoVadis

39/100



Contact :

Nathalie DEBONO

Nathalie.debono@nap.com.pl

Tel: +48 22 699 845 647

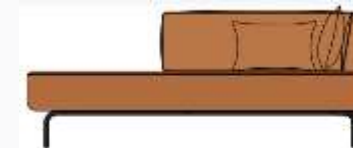

A Parla é especializada no fabrico de mobiliário solto e fixo sofisticado e de alta qualidade + marcenaria para interiores comerciais. A Parla também possui o seu próprio portfólio de produtos concebidos por designers internos e de renome internacional. A Parla Collection está agora a alcançar um crescimento consistente no Reino Unido, Europa, EUA e GCC, com uma excelente rede de revendedores, distribuidores e colaboradores. *network of dealers, distributors and collaborators.*

-35 % en el folleto
2 años de garantía

RSE

- ✓ Materiais reciclados
- ✓ Programa Segunda Vida
- ✓ Concepção ecológica

Services

Feito sob medida

Personalização do produto

Production : Turkey

Certifications :

ISO 9001, ISO 14001



Contact :

Neslihan Mingu
neslihan.mingu@parladesign.com
+90 5309612387

<https://parladesign.com/>



Range Eco - Mid - Prem - Luxury - Lifestyle



Presence on ACCOR concepts

Novotel Riyadh Sahafa - Saudi Arabia, Riyadh

parla*

ASTORE



COVERED COUNTRIES: EMEA & USA

Como parceiro privilegiado dos principais grupos hoteleiros, a RBC é capaz de responder a todas as necessidades de FF&E e ajudar na conceção das várias áreas de um hotel, restaurante ou cozinha; desde o átrio até aos quartos, incluindo salões, salas de conferências, salas de jantar ou mesmo áreas de bem-estar ou exteriores, respeitando a arquitetura do local e o projeto imaginado pelo designer ou pelo cliente.

De 16% a 40%
Nos preços públicos da RBC

Services

- Feito sob medida X
- Modificação dos produtos do catálogo X

[Website](#)

Score EcoVadis
65/100



Contact :
Gianluca Tedesco
gianluca.tedesco@rbcmobilier.com
+ 33 6 86 13 81 41



Midscale-Premium range

Selection of their suppliers : ARPER | CASSINA | EMU | GERVASONI | GUBI | INCLASS | KNOLL | ZANOTTA



Pole Position, um fabricante francês de sofás desde 1991, reflete o artesanato francês. Cada sofá é feito à mão por artesãos qualificados usando métodos de fabricação industrial

Preços de catálogo -10% para Accor
Preços negociados por projeto

RSE	Product range
Materiais reciclados x	Sofás conversíveis, fixos, com capa removível, modulares, capas separadas disponíveis ✓
Programa Segunda Vida	✓ Customisation available ✓
Concepção ecológica	

Production: FRANCE

Sourcing: FRANCE & EUROPE

Return service:

Disponível sob consulta



EcoVadis Score: TBC



Contact:

Valentine Thevenin
Mobile: +33 6 33 31 11 87
valentine.thevenin@home-and-furniture.netplalarme@homespirit.fr

Range Eco - Midscale - Upscale



Company specialized in seats and furniture manufacturing. They can offer customized products. Their factories are specialized in upholstery, foam cutting, leather and fabrics cutting and wood treatment.

De -35% a -40%
Na ROSET public rates

 Midscale to Upscale range



RSE

- Materials reciclados ✓
- Programa Segunda Vida ✓
- Conceção ecológica ✓

Services

- Feito sob medida ✓
- Pequenas modificações nos produtos do catálogo ✓

Certifications



EcoVadis score

55/100



[Website](#)

Production : FRANCE

Sourcing : EUROPE

Serviço de recolha Não



Contact :

Max Flageollet
 +33 6 80 89 08 09
mflageollet@roset.fr

ligne roset®
 CONTRACTS

A RESISTUB PRODUCTIONS é um fabricante francês de mobiliário em metal, madeira e tecido desde 1953. O seu gabinete de design interno pode satisfazer e personalizar todos os pedidos: acabamentos, dimensões e até mesmo acessórios completos.

Range Eco / Midscale

-20%
Sobre preços públicos para encomendas <1000€

-30%
Sobre preços públicos para encomendas >1000€

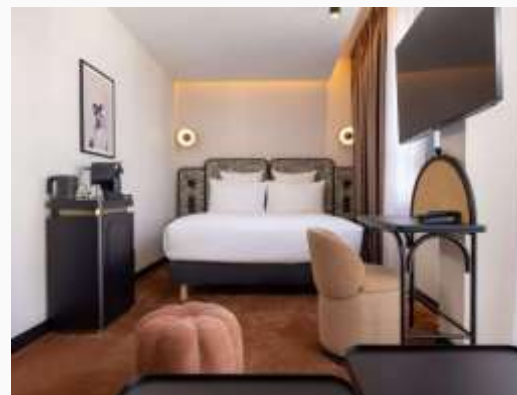

RCS	Services
Materials reciclados ✓	Feito sob medida ✓
Programa Segunda Vida ✓	Modificação dos produtos do catálogo ✓
Concepção ecológica ✓	

Production : FRANCE, POLAND

Sourcing : NORTHERN EUROPE

Serviço de recolha de móveis Não

Certifications



Score EcoVadis

62/100



Contact :

Amandine GRAVOUIL

Tél : +33 6 50 40 25 99

Amandine.gravouil@resistub.com

Serax é uma marca belga que cria design de interiores contemporâneo, com base em colaborações com arquitetos, chefs e designers de renome (inter) nacional. As nossas coleções valorizam qualquer espaço de hospitalidade, dando as boas-vindas aos seus convidados, adicionando personalidade a qualquer interior e criando momentos inesquecíveis à mesa de jantar. Fabricadas por artesãos qualificados em diferentes regiões do mundo, todas as coleções da Serax são únicas pelo seu design e materialidade.

Para encomendas inferiores a 500 unidades por encomenda: preço de tabela de hospitalidade -25%
 Para encomendas superiores a 500 unidades por encomenda: preço de tabela de hospitalidade -30%



As coleções da Serax são adequadas para todas as marcas da Accor. Desde as mais económicas, passando pelas de gama média, até às ultra

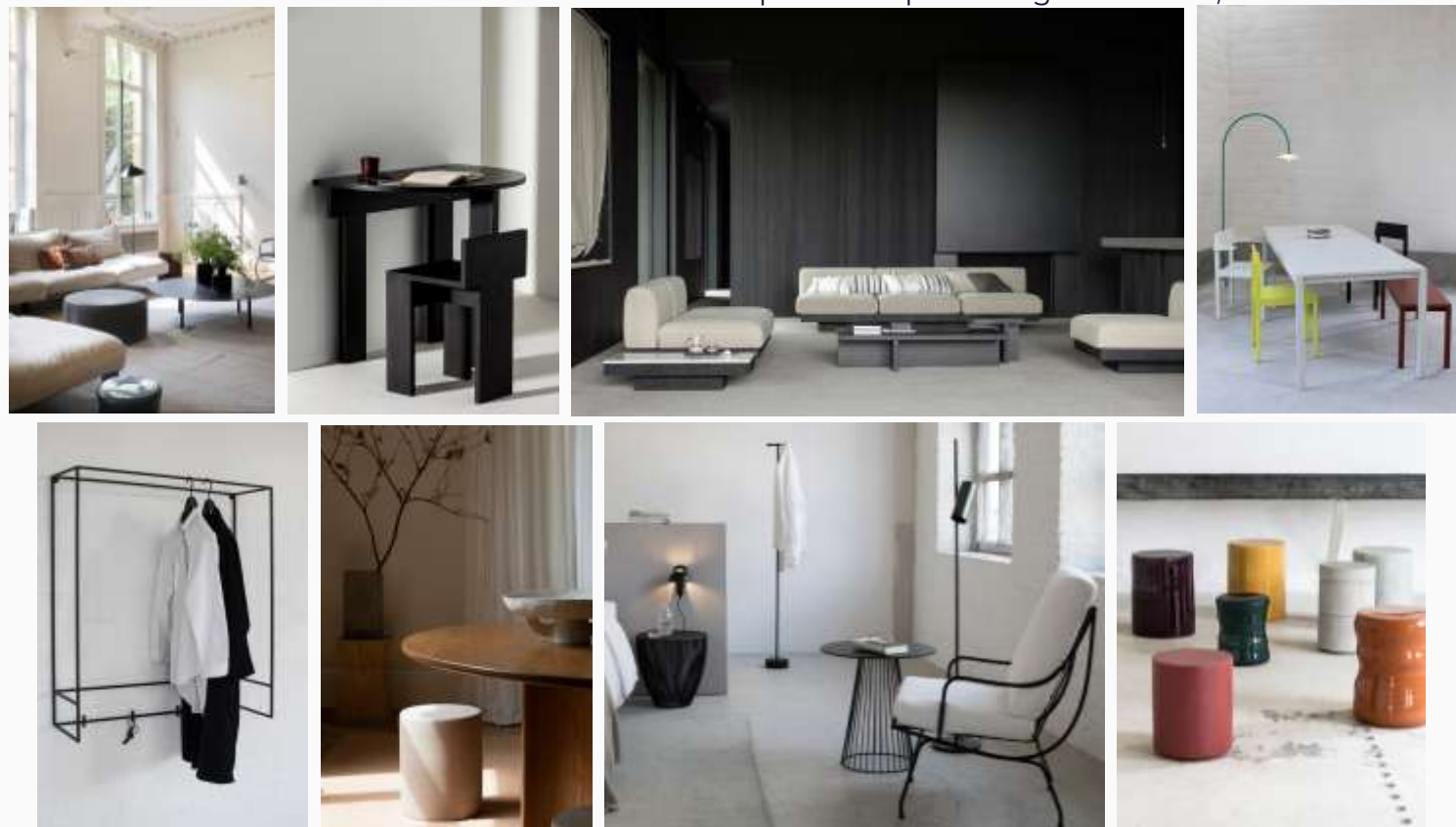

RSE	Services
Materiais reciclados	X
Programa Segunda Vida	X
Concepção ecológica	X
	Feito sob medida
	Modificação dos produtos do catálogo

X

TBC

Production : Worldwide

Sourcing : Worldwide

Serviço de recolha de móveis Não

Certifications

N/A

EcoVadis Score
55/100



www.serax.com
media.serax.com



Contact :

Nico Sas – Hospitality Director
nico.sas@serax.com

Sophie Baldewyns – International
 Key Account Manager Hospitality
sophie.baldewyns@serax.com

Headoffice + showroom
 SERAX - Veldkant 21, 2550 Kontich, Belgium

SERAX

valerie_objects

A Siltec é distribuidora de mobiliário para interiores, conferências, escritórios e exteriores desde 1977. A Siltec está presente em França e no estrangeiro.

All range

Preços Accor negociados Dependendo da marca

RCS

Materiais reciclados

Segunda

programa de vida

Services

Feito à medida

Modificação de produtos

Sourcing :EUROPE

Certifications



Retirada de móveis serviços No
Score EcoVadis 36/100



Selection of manufacturers : AKABA | ALEA | ANDERSSEN | AND TRADITION | ARFLEX | ARTIFORT | ENEA | FANTONI | FENABEL | FORNASARIG | FRITZ HANSEN | GARNAS | HAY | ICF | INNOVATION LIVING | KARL ANDERSSON | LAPALMA | LINTEX | MARA SRL | MARTEX | MATER | MDF ITALIA | MENU | MINIFORMS | MONTANA | MUUTO | NORMANN COPENHAGEN | NORR11 | ONDARRETA | PAOLA LENTI | PEDRALI | RESISTUB | SANCAL | SCANDINAVIAN ULPHOLSTERY | SOFTLINE DK | VARASCHIN | VIBIA | WALTER KNOLL | WILKHAHN | WITTMANN | ZANOTTA

Contact :
 Célia CHABIN cchabin@siltec-mobilier.com Tel: +33 1 42 66 09 13

Criada em 1990, a SILVERA é hoje um conceito global com 11 showrooms em Paris, um centro logístico de 6000 m², mais de 500 marcas internacionais e francesas distribuídas e a loja online SILVERA –eshop.store

Preços Accor negociados Dependendo das marcas

RSE

- Materials reciclados ✓
- Programa Segunda Vida ✓
- Concepção ecológica ✗

Services

- Feito sob medida ✗
- Pequenas modificações nos produtos do catálogo ✓

Production: n/a (distributeur)

Sourcing: EUROPE

Certifications



Servicio de recogida de muebles No

EcoVadis Score

82/100



Contact :

Bertrand Boutin
Tel: +33 6 44 26 32 91
b.boutin@silvera.fr

[Website](#) (french version)



Midscale to Upscale range



Selection of their suppliers: ACTIU | ARPER | FRITZ HANSEN | POLIFORM | ZANOTTA | BENE | FRAMERY | GUBI | HAY

SILVERA

Fundada em 1982, a SOCA fabrica mobiliário contemporâneo e personalizado para o setor hoteleiro. A SOCA tem três especialidades principais: criação de mobiliário personalizado, marroquinaria e estofos.

-40% Nas tarifas públicas da SOCA

RSE

- Materials reciclados ✓
- Programa Second Life ✓
- Design ecológico ✓

Services

- Feito à medida ✓
- Pequenas alterações nos produtos do catálogo ✓

Production : FRANCE

Sourcing : FRANCE

Serviço de recolha Não



Contact :

Jacques DE MASCUREAU
j.de.mascureau@soca.fr
Tel: +33 2 40 68 85 10

Frédérique Joussemet
fjoussemet@soca.fr
Tel: +33 2 40 68 85 10

Certifications



EcoVadis Score
53/100



Eco - Midscale – Upscale ranges



[Website](#)

Table Place Chairs - UHS



A UHS é um fabricante italiano de mobiliário de design para o mundo profissional. Fabrica produtos personalizados para se adequarem a todas as gamas hoteleiras. A UHS conta com uma equipa dedicada de designers e especialistas em produtos com um profundo conhecimento da indústria e dos produtos.

Range Eco-Midscale /Premium

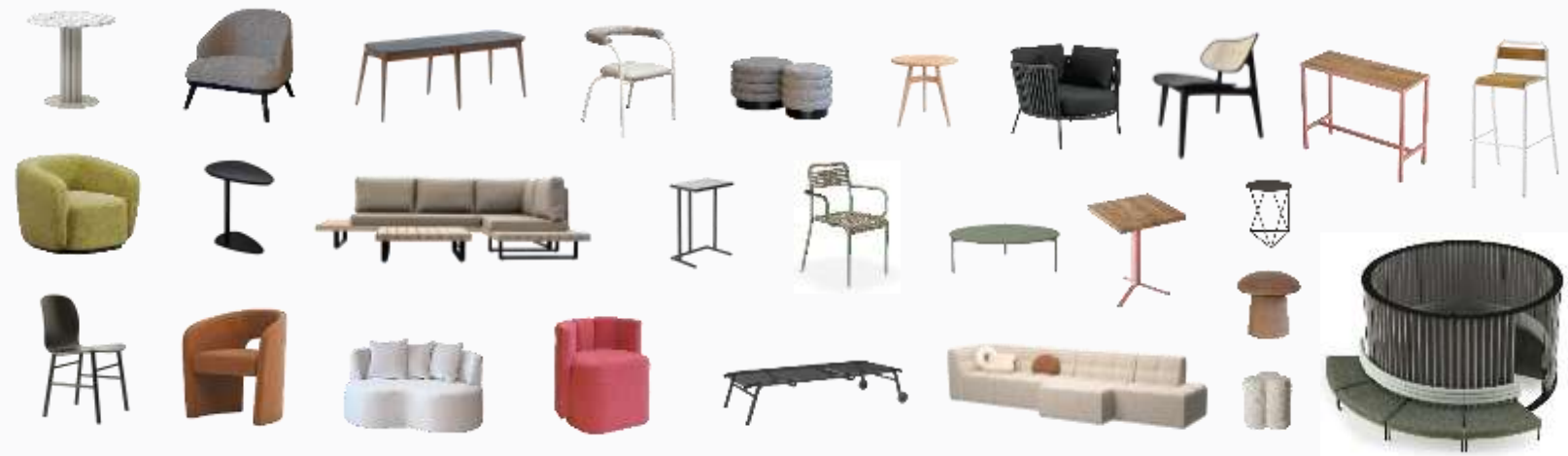

RCS

- Materials reciclados ✓
- Programa Second Life ✓
- Design ecológico ✓

Services

- Feito à medida ✓
- Pequenas alterações nos produtos do catálogo ✓

Production : ITALIE

Sourcing : EUROPE

Certifications



Score EcoVadis

TBC

Serviços de recolha de mobiliário Não

Contact :

Martin JARZAT
 Tel : +33 (0)6 09 42 83 75
Martin.jarzat@tableplacechairs.com



Fabricante suíço de mobiliário contemporâneo desde 1950, a Vitra produz mobiliário para escritórios, residências e espaços públicos.

-36% Sobre as tarifas públicas da VITRA

RSE

- Materialis reciclados ✓
- Programa Segunda Vida ✓
- Concepção ecológica ✓

Services

- Feito sob medida ✗
- Pequenas modificações nos produtos do catálogo ✓

Certifications



Production : GERMANY

Sourcing : EUROPE

Serviço de recolha Não

EcoVadis score
55/100



 [Website](#)



Midscale to Upscale range



vitra.

A Wiesner-Hager é um fabricante austríaco de mobiliário fundado em 1921. Oferecemos coleções personalizáveis e de alta qualidade para restaurantes, átrios e áreas de pequeno-almoço. A nossa gama de produtos inclui também mobiliário para espaços de reuniões e eventos, bem como para salas de reuniões. É possível organizar entregas em toda a região EMEA.



-40% Nas tarifas profissionais da Wiesner-Hager *

Services

- Feito sob medida ✗
- Pequenas modificações nos produtos do catálogo ✓

Production: Austria

Certifications

Sourcing: Austria

 [Website](#)



Score EcoVadis
70/100



Contact :

Lisa Feichtenschlager
l.feichtenschlager@wiesner-hager.com
Tel: +43 664 618 26 23
English, German

Headquarter/Production: Wiesner-Hager, Linzerstraße 22, 4950 Altheim, Austria

*EXW prices

List of Nominated Suppliers

PORTUGAL



Furniture & Design

OUTDOOR FURNITURE

AGENCIA

AKULA LIVING

ALMA SANCTURA

AUDIENCE & CRÉATION

FERMOB

LIGNE ROSET

MADE IN DESIGN

MAISONS DU MONDE

NAP

PARLA DESIGN

RBC

RICHARD MOBILIER

SERAX

SILTEC

SILVERA

TABLE PLACE CHAIRS

VITRA

VLAEMYNCK

A Agencia Europe baseia-se, acima de tudo, nos valores humanos, em pessoas empenhadas que colocam os seus conhecimentos e experiência ao serviço dos clientes para apoiar os seus projetos com total transparência. Como especialista em ordenação do espaço, a Agencia Europe ouve-o e apoia-o, oferecendo-lhe um serviço de consultoria, design e soluções de mobiliário, bem como um serviço de gestão e instalação de FF&E e OS&E.

 Eco-Midscale / Upscale

Entre un -26 % y un -40 %, dependiendo de la marca. Sobre los precios públicos sin IVA.

RSE

- Materials reciclados ✓
- Programa Second Life ✓
- Concepción ecológica ✓

Production: EUROPE

Recuperação de móveis? ✓

Services

- Personalizado ✓
- Modificação dos produtos do catálogo ✓

Certifications



Eco Vadis Score

TBC



Contact :

Thierry CAMPOLUNGI
thierry.campolunghi@agenciagroupe.com
 Mobile : +33 6 26 30 99 99



**NOS PARTENAIRES
 OUTDOOR**



AGENCIAMEA
 LA CONCEPTION DU BIEN-ÊTRE



<https://www.agenciagroupe.com/>

A Akula é um fabricante global de mobiliário de exterior de qualidade marítima, oferecendo uma vasta gama de produtos em stock e capacidades personalizadas, especificamente concebidos para satisfazer os exigentes requisitos do setor hoteleiro. A Akula possui e opera as suas próprias instalações de fabrico, supervisionando o controlo de qualidade em todas as fases da produção.



-25% on the brochure
5-year warranty

RSE

Materiais reciclados



Programa Segunda Vida



Conceção ecológica



Production : China, UK, US

Services

Feito sob medida



Personalização do produto



Certifications :

ISO 9001, ISO 14001



Range Eco - Mid - Prem - Luxury - Lifestyle



Presence on ACCOR concepts

Fairmont Breakers - Fairmont Cape Grace, South Africa

Fairmont Century Plaza - Fairmont Dallas - Fairmont Kea Lani

Contact :

Tom DUNNE
tom@akulaliving.com
+44 1937 862705



<https://akulaliving.com/>



COVERED COUNTRIES: WORLDWIDE

akula

ASTORE

A Alma Sanctura é um coletivo especializado em mobiliário contratado, que oferece soluções completas de mobiliário contratado individual e serviços de estofamento para os setores de hotelaria, restauração e promoção residencial. A Alma Sanctura representa um portfólio diversificado de marcas nacionais e internacionais. Como compromisso com a sustentabilidade, o programa ecoSanctura apoia o uso de móveis ecológicos entre os nossos parceiros.

-25% no folheto
Garantia de 1 a 15 anos contra defeitos de fabrico

RSE

Materiais reciclados

Programa Second Life

Concepção ecológica

Services

personalizado

Modificação dos produtos do catálogo

Production : Singapore, Malaysia, Indonesia, China & Belgium

Contact :

Vanessa LIM
sales@almasanctura.com
 +65 9625 3744



<https://www.almasanctura.com/>



Range Eco - Mid - Prem - Luxury - Lifestyle



ALMA
Sanctura



Como fabricante francês de mobiliário metálico e criador de cores no jardim, a Fermob tornou-se especialista no design integral de espaços exteriores graças à sua vasta gama de mobiliário, iluminação e acessórios decorativos.

35% de desconto sobre preços públicos sem impostos

- | | | | |
|--|--|------------------|---|
| RSE | | Serviços | |
| ✓ Materiais reciclados e recicláveis | | ✓ Feito à medida | ✓ |
| ✓ Programa Second Life  | | ✓ Personalizado | ✓ |
| ✓ Análise 100% do Ciclo de Vida | | | |
| ✓ Scanner de carbono Accor | | | |
| ✓ Pinturarenovação  | | | |
| ✓ Coleção de móveis | | | |



Certificações
 NF EN 581-1
 NF EN 1022
 NF EN 581-3
 NF EN 581-2

Score EcoVadis
 68/100



 [Fermob-contract.com](https://fermob-contract.com)

Production : France 
Sourcing : France, Europe, Asie

 **Contato :**

Agnes camacho
ACAMACHO@fermob.com
 Mobile : +33 (0)6 89 01 39 24



Collection RESTO, LUXEMBOURG



Collection LUXEMBOURG



Collection GARDEN OFFICE



Collection SWIING



Collections BELLEVIE, BEBOP, LORETTE

Sede: Parc Actival 01140 Thoissey
Showroom Professionnel: 79 avenue Ledru Rollin 75012 PARIS
 Neumarkt 49, 50667 Köln, ALLEMAGNE

LIGNE ROSET CONTRACT



-35% a -45%
sobre as tarifas públicas da ROSET

RSE

Materialis reciclados ✓

Programa Second Life ✓

Conceção ecológica ✓

Production : FRANCE

Sourcing : EUROPE

Serviços

Feito à medida ✓

Pequenas modificações nos produtos do catálogo ✓

Certifications



EcoVadis score

55/100



[Website](#)

Contato :

Max Flageollet
+33 6 80 89 08 09
mflageollet@roset.fr

Gama Midscale a Upscale



ligne roset®
CONTRACTS

Como líder europeu no comércio online de mobiliário de design, iluminação e artigos para o lar, a Made In Design tem na sua gama algumas das maiores marcas (Hay, Foscarini, etc.) e designers de renome (Starck, Dixon, etc.).

-20% Sobre os preços públicos*
 Made in Design

 Range Premium



Services

Feito sob medida

Catálogo de produtos modificados

Score EcoVadis

52/100



Contact

Charlène LASSALLE
classalle@madeindesign.com
 Tel: +33 4 38 12 34 75

X
✓



Selection of their manufacturers : HAY | MUUTO | ETHNICRAFT | KARTELL | VITRA | POLS POTTEN | FATBOY | FLOS | ARTEMIDE | ASTRO LIGHTING | SANCAL | & TRADITION | NORMAN COPENHAGEN | GUBI

Office: 32 rue de Comboire - 38130 ECHIROLLES

*Prices expressed in EXW

made in design
 by PRINTEMPS

A Maisons du Monde é uma empresa francesa criada em 1996. É especializada no fabrico e distribuição de mobiliário e decoração para interiores e exteriores. Com a sua equipa integrada de designers, dispõe de uma vasta gama de produtos.

Eco-Midscale Range



From -7% to -14%

Na Maisons du Monde, tarifas públicas para todas as encomendas superiores a 1000 €.

RSE

Materiais reciclados ✓

Programa Segunda Vida ✓

Concepção ecológica ✗

Services

Feito sob medida ✗

Pequenas modificações nos produtos do catálogo ✗

Production: FRANCE, ASIA, EUROPE

Sourcing : EUROPE

Certifications



Serviço de recolha No

EcoVadis Score
68/100



[Website](#)

Contact :

Fabienne Sacareau
fsacareau@maisonsdumonde.com Tel: +33 6 08 54 05 52



A NAP é uma empresa polaca fundada em 2005, especializada no fabrico de mobiliário estofado. A empresa também produz mesas, cadeiras e bancos e distribui várias marcas líderes (Ethnicraft, Mullan, Jensen, etc.).



RCS

Materialis reciclados ✓

Programa Segunda Vida ✓

Concepção ecológica ✓

Services

Feito sob medida ✓

Modificação dos produtos do catálogo ✓

Production : POLAND

Sourcing : EUROPE

Certifications

None

Serviço de recolha de móveis Não

Score EcoVadis

39/100



Contact :

Nathalie DEBONO
Nathalie.debono@nap.com.pl
 Tel: +48 22 699 845 647



Eco- Premium range



A Parla é especializada no fabrico de mobiliário solto e fixo sofisticado e de alta qualidade + marcenaria para interiores comerciais. A Parla também possui o seu próprio portfólio de produtos concebidos por designers internos e de renome internacional. A Parla Collection está agora a alcançar um crescimento consistente no Reino Unido, Europa, EUA e GCC, com uma excelente rede de revendedores, distribuidores e colaboradores. *network of dealers, distributors and collaborators.*

-35 % en el folleto
2 años de garantía

RSE

- ✓ Materiais reciclados
- ✓ Programa Segunda Vida
- ✓ Conceção ecológica

Services

- ✓ Feito sob medida
- ✓ Personalização do produto

Production : Turkey

Certifications :
ISO 9001, ISO 14001



Contact :

Neslihan Mingu
neslihan.mingu@parladesign.com
+90 5309612387

<https://parladesign.com/>



Range Eco - Mid - Prem - Luxury - Lifestyle



Presence on ACCOR concepts
Novotel Riyadh Sahafa - Saudi Arabia, Riyadh

parla*

ASTORE

Como parceiro privilegiado dos principais grupos hoteleiros, a RBC é capaz de responder a todas as necessidades de FF&E e ajudar na conceção das várias áreas de um hotel, restaurante ou cozinha; desde o átrio até aos quartos, incluindo salões, salas de conferências, salas de jantar ou mesmo áreas de bem-estar ou exteriores, respeitando a arquitetura do local e o projeto imaginado pelo designer ou pelo cliente.

De 16% a 40%
Nos preços públicos da RBC

Services

- Feito sob medida ×
- Modificação dos produtos do catálogo ×

[Website](#)

Score EcoVadis
65/100



Contact :
Gianluca Tedesco
gianluca.tedesco@rbcmobilier.com
+ 33 6 86 13 81 41

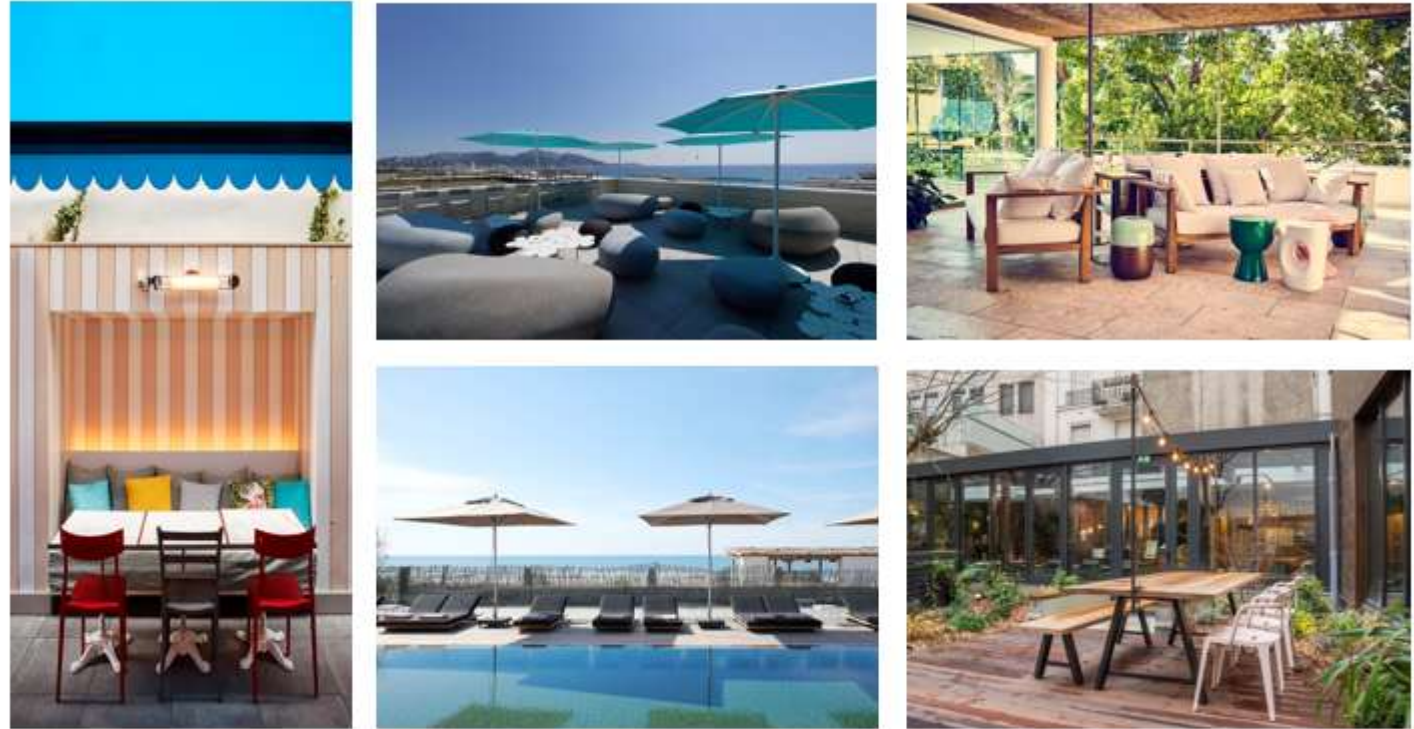

Selection of their suppliers : ARPER | CASSINA | EMU | GERVASONI | GUBI | INCLASS | KNOLL | ZANOTTA



RICHARD MOBILIER

-30%
 On RM public rates

RSE

- Recycled materials ✓
- Second-Life program ✓
- Eco conception ✓

Services

- Custom-Made ✓
- Light modifications on catalog products ✓

Production : FRANCE

Sourcing : FRANCE

Certifications



Take-back service



EcoVadis score

50/100



 Eco-Midscale range



 **Contact :**

Antoine conreau
a.conrau@rm-mobilier.fr
 Tel: +33 6 19 95 07 85

 [Website](#) (french version)



Serax é uma marca belga que cria design de interiores contemporâneo, com base em colaborações com arquitetos, chefs e designers de renome (inter) nacional. As nossas coleções valorizam qualquer espaço de hospitalidade, dando as boas-vindas aos seus convidados, adicionando personalidade a qualquer interior e criando momentos inesquecíveis à mesa de jantar. Fabricadas por artesãos qualificados em diferentes regiões do mundo, todas as coleções da Serax são únicas pelo seu design e materialidade.

Para encomendas inferiores a 500 unidades por encomenda: preço de tabela de hospitalidade -25%
Para encomendas superiores a 500 unidades por encomenda: preço de tabela de hospitalidade -30%

RSE		Services	
Materiais reciclados	X	Feito sob medida	X
Programa Segunda Vida	X	Modificação dos produtos do catálogo	TBC
Concepção ecológica	X		

Production : Worldwide

Sourcing : Worldwide

Serviço de recolha de móveis Não

Certifications

N/A

EcoVadis Score
55/100



www.serax.com
media.serax.com



Contact :

Nico Sas – Hospitality Director
nico.sas@serax.com

Sophie Baldewyns – International Key Account Manager Hospitality
sophie.baldewyns@serax.com

Headoffice + showroom
 SERAX - Veldkant 21, 2550 Kontich, Belgium



Serax collections are suitable for each Accor brand. Going from budget, to mid-scale and ultra-luxury.



SERAX

valerie_objects

A Siltec é distribuidora de mobiliário para interiores, conferências, escritórios e exteriores desde 1977. A Siltec está presente em França e no estrangeiro.



Preços Accor negociados Dependendo da marca

RCS

- Materiais reciclados ✓
- Segunda programa de vida ✗

Services

- Feito à medida ✓
- Modificação de produtos do catálogo ✓

Sourcing :EUROPE

Certifications



Retirada de móveis serviços No **Score EcoVadis** 36/100

Contact :

📧 Célia CHABIN cchabin@siltec-mobilier.com Tel: +33 1 42 66 09 13

 All ranges



Selection of suppliers: ARFLEX | WITTMANN | TECTA | WALTER KNOLL | ZANOTTA | FRITZ HANSEN | SANCAL | HAY | PEDRALI | LAPALMA | PAOLA LENTI | MUUTO | ARTIFORT | ALEA | MARTEX | FANTONI | LINTEX | ICF | WILKHAHN | WALTER KNOLL

Criada em 1990, a SILVERA é hoje um conceito global com 11 showrooms em Paris, um centro logístico de 6000 m², mais de 500 marcas internacionais e francesas distribuídas e a loja online SILVERA –eshop.store

Preços Accor negociados Dependendo das marcas

RSE

- Materials reciclados ✓
- Programa Segunda Vida ✓
- Concepção ecológica ✗

Services

- Feito sob medida ✗
- Pequenas modificações nos produtos do catálogo ✓

Certifications



Production: n/a (distributeur)

Sourcing: EUROPE

Servicio de recogida de muebles No

EcoVadis Score

82/100



Contact :

Bertrand Boutin
Tel: +33 6 44 26 32 91
b.boutin@silvera.fr

[Website](#) (french version)



Midscale to Upscale range



Selection of their suppliers: ACTIU | ARPER | FRITZ HANSEN | POLIFORM | ZANOTTA | BENE | FRAMERY | GUBI | HAY

SILVERA

A UHS é um fabricante italiano de mobiliário de design para o mundo profissional. Fabrica produtos personalizados para se adequarem a todas as gamas hoteleiras. A UHS conta com uma equipa dedicada de designers e especialistas em produtos com um profundo conhecimento da indústria e dos produtos.



RCS

- Materials reciclados ✓
- Programa Second Life ✓
- Design ecológico ✓

Services

- Feito à medida ✓
- Pequenas alterações nos produtos do catálogo ✓

Production : ITALIE

Sourcing : EUROPE

Certifications



Serviços de recolha de mobiliário Não

Score EcoVadis
TBC

Contact :

Martin JARZAT
Tel : +33 (0)6 09 42 83 75
Martin.jarzat@tableplacechairs.com

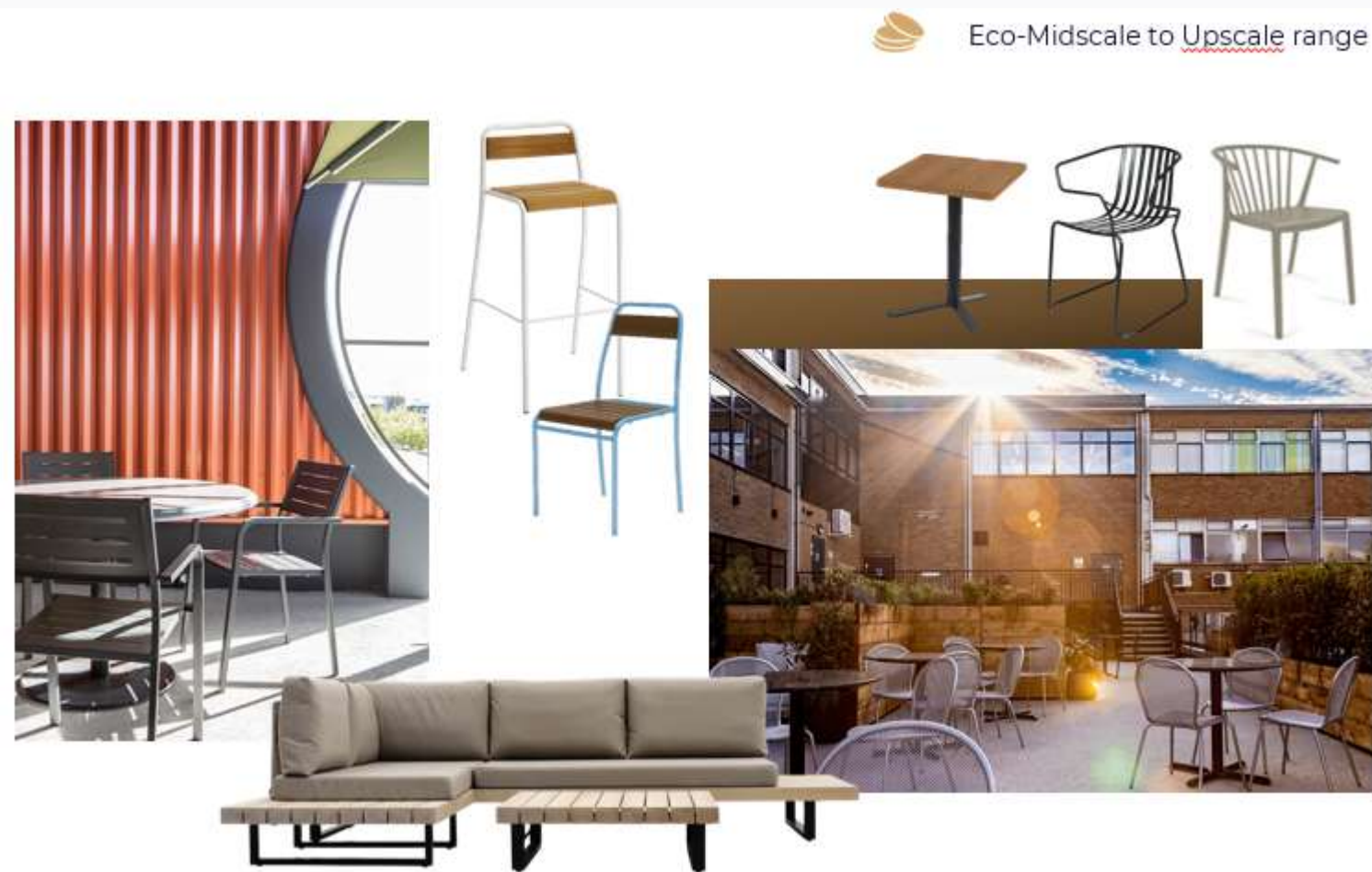

Fabricante suíço de mobiliário contemporâneo desde 1950, a Vitra produz mobiliário para escritórios, residências e espaços públicos.

-36% Sobre as tarifas públicas da VITRA

RSE

Materiais reciclados

Programa Segunda Vida

Concepção ecológica

Services

Feito sob medida

Pequenas modificações nos produtos do catálogo

Certifications



EcoVadis score
55/100



 [Website](#)

Production : GERMANY

Sourcing : EUROPE

Serviço de recolha Não

 **Contact :**

Isabelle DEBUT
 Isabelle.debut@vitra.com
 Tel: +33 1 56 77 07 81
 Mobile : +33 6 61 30 56 40



Midscale to Upscale range





ASTORE

Vlaemynck is a French company specializing in the production of high-end outdoor furniture and parasols for the hospitality and catering industries. Acquired by Fermob in 2013, it is renowned for the quality, durability, and elegance of its products, designed for hospitality professional. Vlaemynck offers a diverse range of chairs, tables, sun loungers, cushions, and parasols, primarily manufactured in its workshops in Bourgogne, France.



VLAEMYNCK



40% off
the public prices excluding taxes

RSE

- Materiais reciclados e recicláveis ✓
- Programa de reutilização Avaliação do ciclo de vida  ✓
- Carbon Scan Accor ✓
- Furniture take back ✓

Services

- Sob medida ✓
- Personalizado ✓



Certifications

- NF EN 581-1
- NF EN 1022
- NF EN 581-3
- NF EN 581-2

Score EcoVadis

61/100



[Fermob-contract.com](https://www.fermob-contract.com)

Production : France 

Sourcing : France, Europe, Asie



Contact :

Michael MORRETON
MMORRETON@fermobcontractunit.com
Mobile : +49 (0)178 729 3055

Headoffice: Parc Actival 01140 Thoissey

*Showroom Professionnels : 79 avenue Ledru Rollin 75012 PARIS
Neumarkt 49, 50667 Köln, ALLEMAGNE*

Collections RIVAGE , PILOTIS, KOTO



Collection GORDES



Collection LODGE

 Upscale



Collections IBIZA, PARASOLS

VLAEMYNCK

ASTORE



Furniture & Design

OFFICE FURNITURE

AGENCIA

LYRECO

SILTEC

SILVERA

VITRA

WIESNER HAGER

List of Nominated Suppliers

PORTUGAL

A Agencia Europe baseia-se, acima de tudo, nos valores humanos, em pessoas empenhadas que colocam os seus conhecimentos e experiência ao serviço dos clientes para apoiar os seus projetos com total transparência. Como especialista em ordenação do espaço, a Agencia Europe ouve-o e apoia-o, oferecendo-lhe um serviço de consultoria, design e soluções de mobiliário, bem como um serviço de gestão e instalação de FF&E e OS&E.

Eco-Midscale / Upscale

Entre un -26 % y un -40 %, dependiendo de la marca. Sobre los precios públicos sin IVA.

RSE

- Materials reciclados ✓
- Programa Second Life ✓
- Concepción ecológica ✓

Production: EUROPE

Recuperação de móveis?

Services

- Personalizado ✓
- Modificação dos produtos do catálogo ✓

Certifications



Eco Vadis Score

TBC



Contact :

Thierry CAMPOLUNGI
thierry.campolunghi@agenciagroupe.com
 Mobile : +33 6 26 30 99 99



NOS PARTENAIRES MOBILIERS, VESTAIRES, RAYONNAGES

- Forma 5
- EOL**
- esPattio**
- MEGABLOK**
- Quinti**
- *Bloomingle
- normann**
COPENHAGEN



<https://www.agenciagroupe.com/>

Lyreco es una empresa familiar francesa creada en 1926 y presente en 42 países con 12 000 empleados, incluidos 2 000 en Francia. Lyreco cuenta con una fuerza de ventas multispecialista y expertos en mobiliario, higiene, soluciones digitales y seguridad, así como un equipo de 450 repartidores equipados con vehículos diseñados para limitar el impacto ambiental. Lyreco ofrece una gama que cubre todas tus necesidades en tu entorno laboral.

Negotiated prices for ACCOR
Sent on request

Range Eco - Midscale - Upscale

Break Areas



Relax & Co-Working Areas



Offices



RSE

- Materials reciclados ✓
- Programa Second Life X
- Concepción ecológica ✓

Services

- Personalizado X
- Modificação dos produtos do catálogo ✓

Production : FRANCE & Europe

Sourcing : FRANCE & Europe

Take-back service?
YES

Certifications



EcoVadis Score
80/100



[Website](#)

Meeting rooms



Reception areas



Staff lockers



A Siltec é distribuidora de mobiliário para interiores, conferências, escritórios e exteriores desde 1977. A Siltec está presente em França e no estrangeiro.

Preços Accor negociados Dependendo da marca

RCS
 Materiais reciclados ✓
 Segunda programa de vida ✗

Services
 Feito à medida ✓
 Modificação de produtos do catálogo ✓

Sourcing :EUROPE

Certifications

Retirada de móveis serviços No
Score EcoVadis 36/100



Contact :

 Célia CHABIN cchabin@siltec-mobilier.com Tel: +33 1 42 66 09 13

 All ranges



Selection of suppliers: ARFLEX | WITTMANN | TECTA | WALTER KNOLL | ZANOTTA | FRITZ HANSEN | SANCAL | HAY | PEDRALI | LAPALMA | PAOLA LENTI | MUUTO | ARTIFORT | ALEA | MARTEX | FANTONI | LINTEX | ICF | WILKHANN | WALTER KNOLL

Criada em 1990, a SILVERA é hoje um conceito global com 11 showrooms em Paris, um centro logístico de 6000 m², mais de 500 marcas internacionais e francesas distribuídas e a loja online SILVERA –eshop.store

Preços Accor negociados Dependendo das marcas

RSE

- Materiais reciclados ✓
- Programa Segunda Vida ✓
- Concepção ecológica ✗

Services

- Feito sob medida ✗
- Pequenas modificações nos produtos do catálogo ✓

Production: n/a (distributeur)

Sourcing: EUROPE

Certifications



Servicio de recogida de muebles No

EcoVadis Score

82/100



Contact :

Bertrand Boutin
Tel: +33 6 44 26 32 91
b.boutin@silvera.fr

[Website](#) (french version)



Midscale to Upscale range



Selection of their suppliers: ACTIU | ARPER | FRITZ HANSEN | POLIFORM | ZANOTTA | BENE | FRAMERY | GUBI | HAY

SILVERA

Headoffice: & Showroom : 58 avenue Kléber 75016 PARIS

Fabricante suíço de mobiliário contemporâneo desde 1950, a Vitra produz mobiliário para escritórios, residências e espaços públicos.

-36% Sobre as tarifas públicas da VITRA

RSE

Materiais reciclados ✓

Programa Segunda Vida ✓

Concepção ecológica ✓

Services

Feito sob medida ✗

Pequenas modificações nos produtos do catálogo ✓

Certifications



EcoVadis score
55/100



 [Website](#)

Production : GERMANY

Sourcing : EUROPE

Serviço de recolha Não

 **Contact :**

Isabelle DEBUT
 Isabelle.debut@vitra.com
 Tel: +33 1 56 77 07 81
 Mobile : +33 6 61 30 56 40



Midscale to Upscale range



A Wiesner-Hager é um fabricante austríaco de mobiliário fundado em 1921. Oferecemos coleções personalizáveis e de alta qualidade para restaurantes, átrios e áreas de pequeno-almoço. A nossa gama de produtos inclui também mobiliário para espaços de reuniões e eventos, bem como para salas de reuniões. É possível organizar entregas em toda a região EMEA.

-40% Nas tarifas profissionais da Wiesner-Hager *

Services

Feito sob medida ✘

Pequenas modificações nos produtos do catálogo ✔

Production: Austria

Sourcing: Austria

 [Website](#)

Certifications



Score EcoVadis

70/100



 **Midscale / Upscale range**



 **Contact :**

Lisa Feichtenschlager
 l.feichtenschlager@wiesner-hager.com
 Tel: +43 664 618 26 23
 English, German

Headquarter/Production: Wiesner-Hager, Linzerstraße 22, 4950 Altheim, Austria

*EXW prices



LIGHTING



LIGHTING

AGENCIA

AROMAS DEL CAMPO

ARTEMIDE

ASTRO LIGHTING

HOEL

BROSSIER SADERNE

RADIAN

ROGER PRADIER

SECURLITE

FERMOB

FARO LOREFAR

FLOS

FRANSEN MADE SPECIFIC

LED C4

MAISON DU MONDE

SERAX

TARGETTI

List of Nominated Suppliers

PORTUGAL

A Agencia Europe baseia-se, acima de tudo, nos valores humanos, em pessoas empenhadas que colocam os seus conhecimentos e experiência ao serviço dos clientes para apoiar os seus projetos com total transparência. Como especialista em ordenação do espaço, a Agencia Europe ouve-o e apoia-o, oferecendo-lhe um serviço de consultoria, design e soluções de mobiliário, bem como um serviço de gestão e instalação de FF&E e OS&E.

Eco-Midscale / Upscale

Entre un -26 % y un -40 %, dependiendo de la marca. Sobre los precios públicos sin IVA.

RSE

- Materials reciclados ✓
- Programa Second Life ✓
- Concepción ecológica ✓

Production: EUROPE

Recuperação de móveis?

Services

- Personalizado ✓
- Modificação dos produtos do catálogo ✓

Certifications



Eco Vadis Score

TBC

Contact :

Thierry CAMPOLUNGI
thierry.campolunghi@agenciagroupe.com
 Mobile : +33 6 26 30 99 99



NOS PARTENAIRES LUMINAIRES



<https://www.agenciagroupe.com/>

Famoso designer italiano, Artemide é líder em iluminação decorativa contemporânea. A Artemide oferece produtos que vão desde opções econômicas até itens de luxo.

-40%
On Artemide public rates

Midscale / Premium range



RSE

Recycled materials



Second-Life program



Eco conception



Services

Personalizado

Modificação dos produtos do catálogo

Production : ITALY, FRANCE, HUNGARY

Sourcing : EUROPE

Certifications



Take-back service

No

EcoVadis Score

TBC



Contact

Philippe BOYER
Tel: + 33 (0)1 43 44 44 47
boyer@artemide.fr



[Website](#)

Showroom: worldwide: Paris, Frankfurt, Chicago, L.A., Miami & New York...

Criada em 1997 na Inglaterra, a Astrolighting tornou-se uma referência no mundo do design e da iluminação criativa. Presente em mais de 90 países, a Astrolighting oferece designs inovadores através da sua equipe interna de engenharia.

Midscale / Premium range

45% sobre as tarifas públicas da Astrolighting

RSE

- Recycled materials ✗
- Second-Life program ✓
- Eco conception ✓

Product range

- Decorative products (wall lamps, floor lamps, suspensions...) ✓
- Architectural products (spots) ✓
- Custom-Made products ✗

Production : EUROPE - CHINA

Sourcing : EUROPE - ASIA

Certifications

N/A

Take-back service

No

EcoVadis Score

65/100



Contact :

Tony Thompson
Tel : +44 (0)1279 594 350
athompson@astrolighting.com



[Website](#)

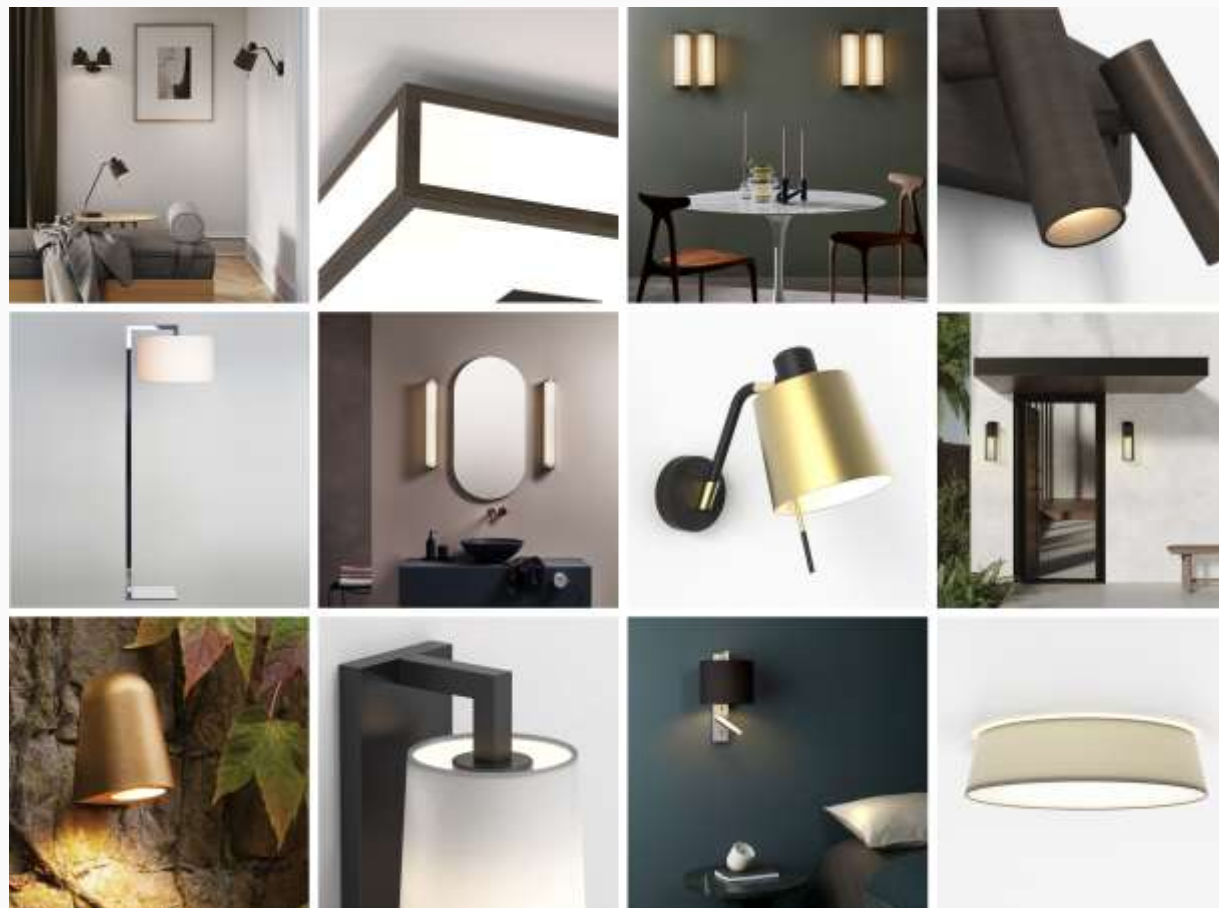

É o catalisador e desenvolvedor de marca da Rivalen, um coletivo de indústrias francesas criado em 2017 para valorizar o saber-fazer das mulheres, que concebem e fabricam soluções de iluminação que combinam funcionalidade, sustentabilidade e respeito pelos materiais. A Rivalen é uma empresa com missão desde abril de 2022. Como especialistas no design e fabricação de luminárias, oferecemos aconselhamento personalizado e trabalhamos consigo para desenvolver as soluções de iluminação ideais para todo o seu estabelecimento. Tudo com Hoël.

Hoël's brands

CSR
Missão
Trajectoria de carbono Economia circula
rEcodesign
Materiais reciclados
 Programa de segunda vida

Services
 Gama completa de luminárias
 Sob medida
 Modificação de produtos do catálogo

	1910 Creation date	Light fixtures Decorative outdoor
	1985 Creation date	Lighting for workspaces and co- working spaces
	1986 Creation date	Light fixtures Functional and technical
	1987 Creation date	Decorative Lighting indoor

Production : France
Sourcing : France and Europe

Business contacts
 France, Spain, Portugal Stéphane Aubry +33685563950

stéphane.aubry@brossier-saderne.com

Showroom by appointment at 12 rue Lamartine - Paris 09

Applications

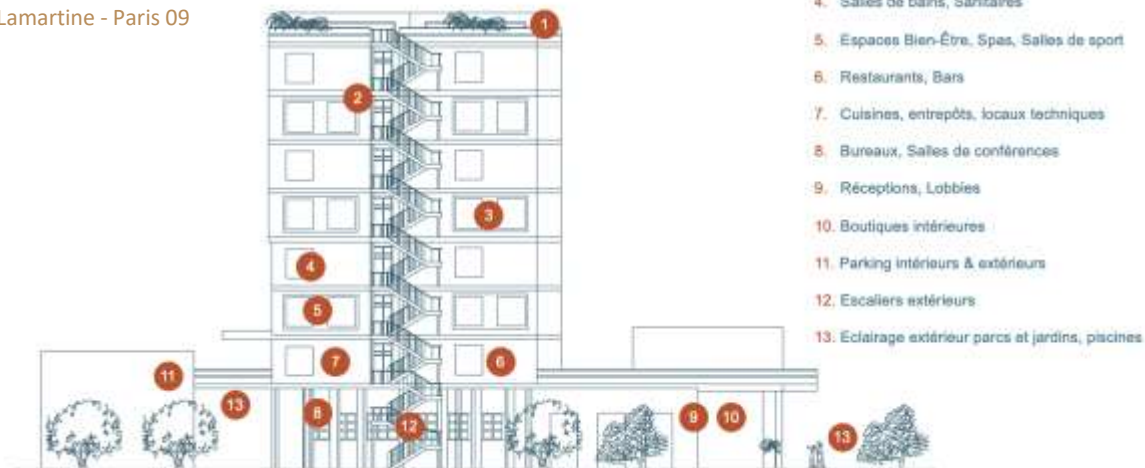

A Brossier Saderne fabrica luminárias para interiores em seus ateliês em Angers, França, desde 1987. A marca beneficia-se de um know-how excepcional, reforçado por um escritório de design interno e uma rede global de mais de 400 parceiros locais, oferecendo acesso a uma ampla gama de materiais e técnicas de fabricação. Como empresa líder no setor hoteleiro, com uma longa história, a Brossier Saderne é reconhecida pela sua capacidade de oferecer soluções de iluminação sob medida



40% de desconto sobre os preços públicos da Brossier Saderne



Eco-Midscale to Premium range

CSR

- Trajetória 2030, redução das emissões de carbono
- Diagnóstico de resíduos com plano de redução
- Desenvolvimento de metodologia de ecodesign
- Implementação de uma abordagem de compras responsáveis
- Reparabilidade
- Economia circular

SERVICES

- Iluminação sob medida: projetamos e fabricamos as suas luminárias em todos os tipos de materiais e acabamentos.
- As luminárias do nosso catálogo podem ser personalizadas para se adaptar ao seu mundo
- substituição de lâmpadas

APPLICATIONS

- Quartos
- Banheiros
- Restaurantes, Bares
- Área de recepção, Lobby...
- Escadas, Corredores
- Bem-estar, Spas
- Áreas de cozinha, Salas de estar (Suítes, Apartamentos de hotel...)
- Escritórios
- Salas técnicas
- Boutiques



Sales contacts

France, Spain, Portugal



www.brossier-saderne.com

Stephane Aubry

+33 6 13 01 79 11

Showroom by appointment: 12 rue Lamartine - Paris 09

stephane,aubry@brossier-saderne.com

Production Angers, France

Sourcing National with over 400 local partners, Europe

Certification



EcoVadis score Silver 76/100

A Radian é um designer, desenvolvedor e fabricante francês de soluções de iluminação para escritórios. Toda a nossa oferta é produzida na região de Nantes; a empresa é um parceiro local, flexível e ágil. A Radian é especialista em ergonomia visual para o ambiente de trabalho, oferecendo luminárias de chão e produtos para teto (suspensões, luminárias embutidas, plafons). Somos certificados ISO 9001 e “garantia de origem França”. Temos um showroom em Paris.

- 40% de desconto sobre os preços públicos
- Custos logísticos: aprox. 5% (a definir conforme orçamento)
- Envio gratuito na França metropolitana: 500 €

CSR

- Trajetória 2030, redução das emissões de carbono ✓
- Produtos altamente recicláveis (alumínio) ✓
- Compras responsáveis ✓
- Raízes locais ✓

Services

- Sob medida e semi-medida ✓
- Todas as cores RAL ✓

Product Range

Iluminação para espaços terciários ✓

APPLICATIONS

- Escritórios, salas de conferência, espaços de coworking
- Espaços habitáveis
- Circulações, corredores
- Áreas de bem-estar, spas, academias
- Restaurantes, bares
- Cozinhas
- Recepções, lobbies
- Lojas...

Production France

Sourcing: Local (40% less than 200km from the factory), National, Europe.

Furniture trade-in service

Yes on street lamps

Contact :

Ludovic Voltz
Chief Executive Officer
+33 6 99 54 31 08
l.voltz@radian.fr

Showroom
5 ter rue d'Arsonval
75015 Paris

Certifications *



EcoVadis Score

69/100

Silver Medal June 2024



[Website](#)



Wall lights



In-wall



Work Lights



Suspensions



Ceiling lights



EcoVadis PRATA Junho 2024
As classificações da EcoVadis oferecem uma visão transparente e imparcial da nossa forma de trabalhar

Garantia de reparabilidade de 10 anos
A Radian pode oferecer a reparabilidade das suas luminárias por um período de 10 anos.

Garantia técnica de 5 anos
Os componentes e peças estão cobertos por uma garantia de 5 anos quando instalados e utilizados conforme previsto.

Roger Pradier®, fundada há mais de um século, é reconhecida pela sua iluminação exterior intemporal, fabricada perto de Châteauroux. Com uma garantia de 25 anos contra a corrosão do alumínio, as suas luminárias são concebidas para resistir a todas as condições climáticas. A empresa oferece uma ampla gama de estilos e soluções personalizáveis, ideais para profissionais de paisagismo. Roger Pradier® está empenhada em ajudar os hotéis e parceiros da Accor a criar espaços exteriores elegantes e sustentáveis.

•40% de desconto sobre os preços públicos
 •Custos logísticos: aprox. 5% (a definir conforme orçamento)
 •Envio gratuito na França metropolitana: 500 €

CSR

- Trajetória 2030, redução das emissões de carbono
- Desenvolver uma metodologia de ecodesign
- Materiais reciclados
- Implementar uma abordagem de compras responsáveis
- Raízes locais, fabricação 100% francesa

SERVICES

- Linha de produtos: iluminação decorativa para áreas externas
Opções: sob medida e semi sob medida
- Acabamentos: 25 cores e 5 materiais
- Garantias



APPLICATIONS

- Áreas externas: fachadas, parques, jardins, acessos aos edifícios
- Terraços, varandas, coberturas
- Áreas ao redor das piscinas, solários
- Restaurantes, bares
- Áreas comuns externas: escadas, corredores, passagens
- Estacionamentos externo



*Hôtel du Palais,
Biarritz
Avenue 4 floor lamp*



*Hotel La Roya,
Saint-Florent
Tetra bollard*



*Hôtel La Fantaisie,
Paris
Louis-Philippe wall lamp 1*



*Hôtel Le Berria,
Hasperren
Lampioik 1 wall lamp*

Production Saint-Maur, France

Certifications

ISO 9001, CE, UL, EAC

EcoVadis score 2023: Bronze 58/100

Living Heritage Company label

French companies with excellent craft and industrial skills



REPUBLIQUE FRANÇAISE



Commercial contacts

France, Spain, Portugal

Stéphane Aubry

+33 6 13 01 79 11

stephane.aubry@brossier-sademe.com

imartinez@roger-pradier.com









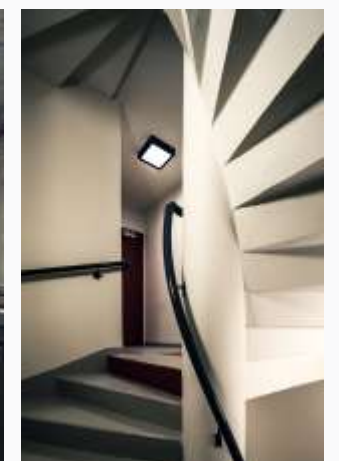

www.roger-pradier.com

Showroom by appointment at 12 rue Lamartine – Paris 09

Desde 1986, **SÉCURLITE** fabrica e desenvolve soluções de iluminação duráveis e de alta resistência para arquitetos e escritórios de design, bem como para proprietários de edifícios e suas instalações. Para a Sécurlite, a iluminação deve combinar conforto, desempenho e durabilidade. As nossas gamas foram desenvolvidas para oferecer uma resposta funcional, fiável e segura a todas as necessidades de iluminação de edifícios públicos movimentados. Eco concebidos, os produtos das nossas gamas foram projetados para otimizar o consumo de energia dos estabelecimentos que equipam e reduzir drasticamente os custos de manutenção. A Sécurlite oferece uma gama completa de iluminação interior/exterior: luminárias circulares, downlights, luminárias lineares e embutidas, bem como soluções técnicas sob medida.

-40% on the housing range
-30% on technical range
Logistics cost: approx. 5% (to be refined according to quote)
Free shipping: €500 excl. VAT in metropolitan France

CSR	SERVICES	APPLICATIONS				
<p>Ética e Social Produção inclusiva integrada no ESAT, patrocínio da Habitat & Humanisme</p> <p>Meio ambiente ecodesign, reciclabilidade, reparabilidade</p> <p>Fabricado na França</p>	<p>Linha Interior/Exterior Opção detecção de presença</p> <p>Soluções técnicas Sob medida</p> <p>Retrofit para produto de segunda vida</p>	<p>Circulação</p> <p>Áreas comuns</p> <p>Salas de serviço Sanitários</p> <p>Varandas</p> <p>Exterior</p> <p>Estacionamento</p>	 <p> www.securlite.com</p>			 <p>Showroom at the head office in La Ferté-Bernard and by appointment at 12 Rue Lamartine – Paris 9</p>
<p>Production France</p> <p>Sourcing France (99% de our suppliers are French)</p>	<p>CERTIFICATIONS</p> <p>Iso 9001, Origine France Garantie, PEP ecopassport RGE étude d'éclairage intérieur</p> <p>Score EcoVadis Or 71/100</p>	 	<p> Business contacts: France / Spain / Portugal :</p>		<p>Stépha,e Aubry +33 6 13 01 79 11 stephane.aubry@brossier-saderne.com</p>	

FERMOB



ASTORE

No Fermob, a luz é como o mobiliário! Fácil de usar, inovadora, elegante e colorida, as nossas luminárias cumprem critérios rigorosos desde o design até à fabricação. Projetadas para serem colocadas, penduradas, transportadas ou fixadas, oferecem uma variedade de cenários de iluminação para múltiplos usos e uma experiência única para o utilizador. uses and a unique user experience



3 de desconto – Preços públicos sem impostos

RSE

- 30% Materiais reciclados ✓
- Programa de segunda vida ✓
- Eco concepção ✓

Services

- Produtos sob medida ✓
- Modificação de produtos do catálogo ✓

Production : France, Asie

Sourcing :

Serviço de recuperação:
oui

Certifications

IEC 60598, NF EN 62262, NF EN 60529
IRCY, IREP

Score EcoVadis

68/100



[Fermob-contract.com](https://www.fermob-contract.com)



Collections , MOON!, HOOPIK, LUXEMBOURG, STUDIE, KATE



Collections MOON!, SURPRISING, COCOTTE



Collection OTO



Collections BALAD, HOOPIK



Collection HOOPIK



Collection APLO



Contact :

Agnès CAMACHO
acamacho@fermobcontractunit.com
Mobile : +33 (0)689 013 924

Bureau: Thoissey (01) - FRANCE

Fermob

ASTORE

Faro Barcelona é uma empresa familiar espanhola criada em 1945. Especializada em iluminação decorativa interior, a Faro também oferece iluminação exterior e uma gama de ventiladores. Destaca-se pelo seu design original e identidade única.



-35% nas tarifas públicas da Faro

Eco-Midscale range

RSE

- Materiais reciclados ✓
- Programa de segunda vida ✓
- Eco concepção ✓

Product range

- Produtos decorativos (aplique, candeeiros de pé, suspensões...) ✓
- Produto arquitetónico (spots) ✓
- Produtos sob medida ✓

Production : ASIA – EUROPE

Sourcing : EUROPE - ASIA

Take-back service
No

Certifications



EcoVadis Score
67/100



Contact

Ana LOPEZ RAVENTOS
Tél: +34 659 878 564
ana.lopez@faro.es

Caroline Pérez
Tél: +34 617 428 604
caroline.perez@faro.es



[Website](#)



Grande nome do design italiano, a FLOS é líder em iluminação decorativa de alto padrão com as suas duas principais gamas: a coleção principal e a gama arquitetónica. Quase 100% da sua produção é feita na Itália.

-40% nas tarifas públicas da Flos

RSE

- Materiais reciclados ✓
- Programa de segunda vida ✓
- Eco concepção ✓

Product range

- Produtos decorativos (applique, candeeiros de pé, suspensões...) ✓
- Produto arquitetónico (spots) ✓
- Produtos sob medida ✓

Certifications



Production : ITALY – ESPAGNE
Sourcing : SOUTHERN EUROPE

Take-back service
No

EcoVadis Score
TBC

Contact

Spain:
Arantza MARTINEZ
arantza.martinez@flos.com

Italy:
Sirio GRECO
sirio.greco@flos.com

[Website](#)

Midscale to Premium range



ASTARI FRANDSEN GROUP



Negotiated prices on project basis

Bespoke only

Product range

Produtos decorativos (aplique, candeeiros de pé, suspensões...)



Produto arquitetônico (spots)



Produtos sob medida



 [Website](#)

EcoVadis Score
TBC



Contact :

Karina Sorensen
Tél: +45 76 58 18 18
karina.sorensen@made-specific.com

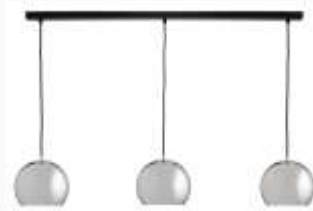

Eco to Premium range



FRANDSEN
PROJECT



-60% nas tarifas públicas da LEDSC4

RSE

- Materiais reciclados ✓
- Programa de segunda vida ✓
- Eco concepção ✓

Product range

- Produtos decorativos (aplique, candeeiros de pé, suspensões...) ✓
- Produto arquitetônico (spots) ✓
- Produtos sob medida ✓

Production : EUROPE – SPAIN - ASIA

Sourcing : ASIA - EUROPE

Take-back service

No

Certifications



EcoVadis Score

75/100



[Website](#)

LEDS-C4



LEDS C4

Showrooms: Barcelona, Moscow, Johannesburg, Casablanca, Dubai, Kuwait, Cairo, Bangkok, Singapur, Mexico, Caracas

Maisons du Monde, inicialmente especializada em mobiliário sólido e decoração, expandiu a sua gama B2B com uma oferta de iluminação, e em lançaram o seu próprio serviço de design de interiores, acompanhado por um designer de interiores para os teus projetos.

% a -14% nas tarifas públicas para todas as encomendas acima de 1.000€

RSE

- Materials reciclados ✓
- Programa de segunda vida ✓
- Eco concepção ✗

Product range

- Produtos decorativos (applique, candeeiros de pé, suspensões...) ✓
- Produto arquitetónico (spots) ✗
- Produtos sob medida ✓

Production: FRANCE, ASIA, EUROPE

Sourcing: EUROPE, ASIA

Certifications



Take-back service
Non

EcoVadis Score

68/100

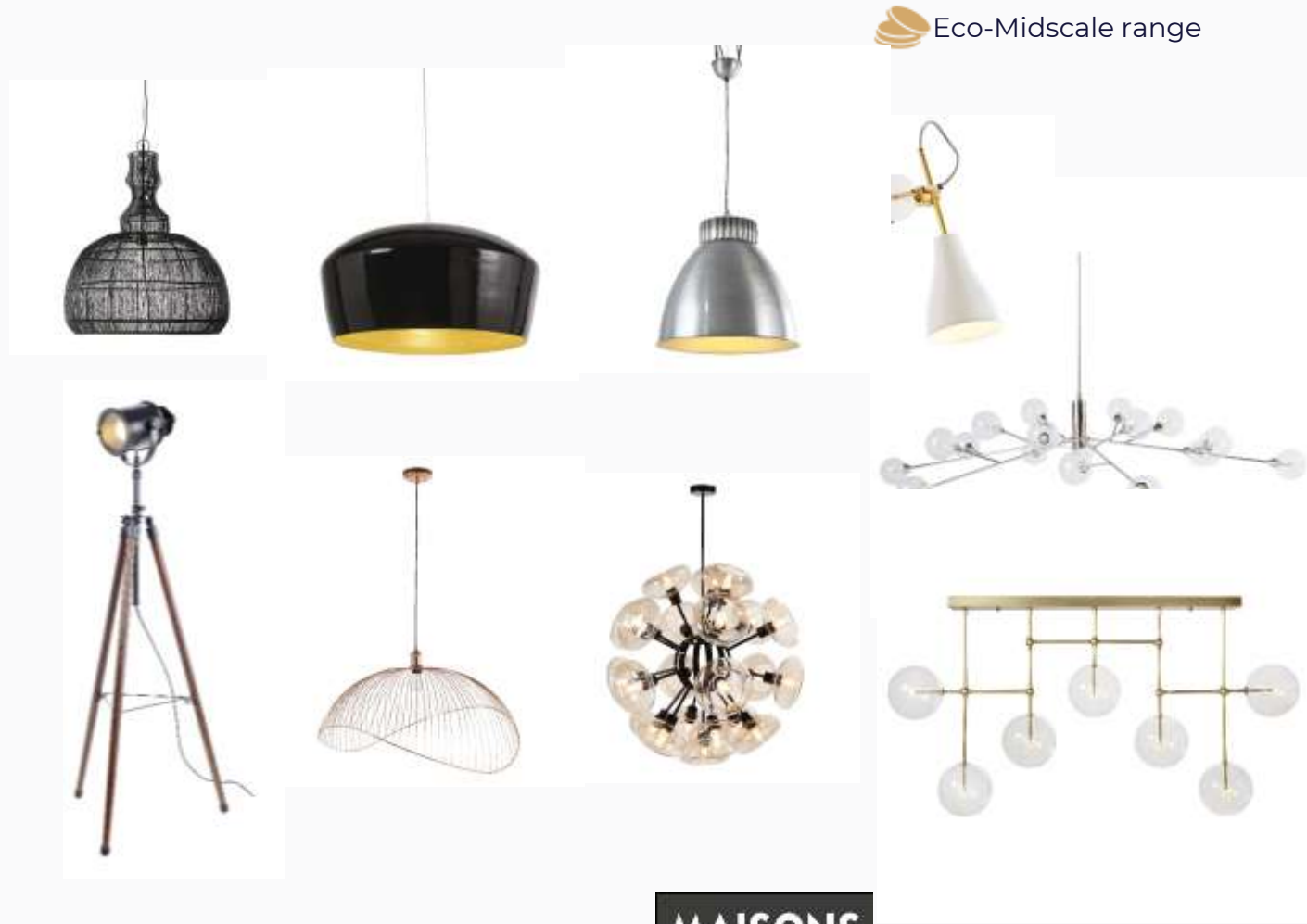

 Eco-Midscale range

 **Contact :**

Fabienne Sacareau
fsacareau@maisonsdumonde.comTTel: +33
08 54 05 52

 [Website](#)

*Showrooms: Maisons du Monde - 6 rue Anne de Bretagne - Immeuble Viséo - 44 120 Vertou (France)
Maisons du Monde Show Room PRO: 5 boulevard Montmartre
75002 Paris (France)*



Serax é uma marca belga que cria design de interiores contemporâneo, baseada em colaborações com arquitetos, chefs e designers renomados (inter)nacionais. As nossas coleções valorizam qualquer espaço de hospitalidade, dando uma receção calorosa aos teus convidados, acrescentando carácter a qualquer interior e criando momentos inesquecíveis à mesa. Fabricadas por artesãos qualificados em diferentes regiões do mundo, todas as coleções Serax são únicas pelo seu design e materialidade.



- Para encomendas inferiores a 500 peças por encomenda: preço de lista para hotelaria -25%
- Para encomendas superiores a 500 peças por encomenda: preço de lista para hotelaria -30%

 Serax collections are suitable for each Accor brand. Going from budget, to mid-scale and ultra-luxury.

RSE

Materiais reciclados

X

Programa de segunda vida

X

Eco concepção

X

Product range

Produtos decorativos (aplique, candeeiros de pé, suspensões...)

X

Produto arquitetónico (spots)

X

Produtos sob medida

X



Production : Worldwide

Sourcing : Worldwide

Take-back service?

No

Certifications

N/A

EcoVadis Score

53/100



www.serax.com
media.serax.com



SERAX

valerie_objects

 **Contact :**

Nico Sas – Hospitality Director
nico.sas@serax.com

Sophie Baldewyns – International
Key Account Manager Hospitality
sophie.baldewyns@serax.com

Headoffice + showroom
SERAX - Veldkant 21, 2550 Kontich, Belgium

Targetti é um fabricante italiano com designs clássicos e contemporâneos. Podem produzir produtos sob medida mediante solicitação quando as quantidades encomendadas são suficientemente grandes.



-40%
nas tarifas públicas da Targetti

Product range

Produtos decorativos e arquitetónicos (aplique, candeeiros de pé, suspensões, espelhos...)



Produtos sob medida



[Targetti Website](#)

[MLE Website](#)

EcoVadis Score

51/100



Contact :

Nathalie Maia
06 68 00 55 06
nathalie.maia@targetti.com

Showrooms: Paris, Singapour, Copenhagen, Stockholm, Düsseldorf, Fort Lauderdale, Tokyo, Oslo, Leewarden, Kriens (Switzerland), Helsinki.



Eco-Midscale range





Furniture & Design

ACCESSORIES

PIERRE PRADEL / MP GLASS

BULBS

SIGNIFY

List of Nominated Suppliers

PORTUGAL

PIERRE PRADEL / MP GLASS

Há mais de 45 anos que a Pradel é uma marca francesa líder de espelhos de casa de banho profissionais. Focada exclusivamente no comércio profissional e no mercado hoteleiro, a Pradel oferece espelhos iluminados ou padrão, armários para banheiro e espelhos cosméticos de alta qualidade com designs inovadores. Com base na sua experiência na indústria de espelhos, e mais especificamente em espelhos iluminados, a missão da Pradel é oferecer-lhe produtos inovadores, de alta qualidade e eco-responsáveis que vão ao encontro das últimas tendências do mercado.



-50%

sobre os preços públicos do catálogo geral PRADEL

RCS

Espelho sem chumbo sem cobre ✓

Reparabilidade do espelho ✓

5 anos de garantia ✓

Produção : EUROPA, ASIA

Abastecimento: EUROPA, ÁSIA

Serviço pós-venda
SIM

Servicios

Espelhos específicos para a hotelaria ✓

Uma equipa especializada ✓

Espelhos cosméticos topo de gama ✓

Certificações



EcoVadis:
67/100

Conceito Accor, espelho padrão, espelho personalizado e espelho cosmético de aumento



Contatos:

Félix TRUONG - Tel: +33 7 48 10 05 42

Céline MAYENCON - Tel: +33 4 82 54 04 19

Mail : contact-hotel@pierrepradel.com



Sítio web

www.pierrepradel.com / Para mais informações sobre os nossos produtos, por favor contacte-nos por telefone ou e-mail



PRADEL

SIGNIFY











A Signify é líder mundial em iluminação. Oferecemos produtos, sistemas e serviços de alta qualidade e energeticamente eficientes. As nossas soluções de iluminação conectada: Ao redefinir o que a luz pode fazer e como as pessoas a utilizam, as nossas inovações contribuem para um mundo mais seguro, inteligente e sustentável.

As soluções MyCreation são luminárias impressas em 3D com materiais reciclados e recicláveis

Score EcoVadis
84/100



Eco - Midscale - Upscale

 Contributing to the circular economy	 Solving CO2 emissions	 Disposing of waste
 The aim is to produce all printed parts with at least 65% recycled or bio-circular plastics.	 Up to 76% fewer emissions for materials supply and manufacturing	 No stock, no unsold stock thanks to print-on-demand
 up to 40% fewer components	 Up to 28% fewer carbon emissions from transport	 Using waste to create products
 Easy to dismantle		 towards zero waste production

Distributors

[LEGALLAIS](#)

[SIDER](#)

[SONEPAR](#)

[REXEL](#)



<https://www.signify.com/global/myCreation> Iluminações

Contato:

Laurent GUILLOT

Laurent.guillot@signify.com

Mobile : +33 7 85 61 27 47



Oficina: Signify, 33 rue de Verdun, CS60019 – 92156 Suresnes



Signify
myCreation

ASTORE



SOFA BEDS

List of Nominated Suppliers

PORTUGAL

Furniture & Design

CONVERTIBLE SOFAS

- AGENCIA
- BK ITALIA
- COLLINET
- DORELAN
- HOME SPIRIT
- LIGNE ROSET
- MADE IN DESIGN
- POLE POSITION
- SILTEC

CONVERTIBLE ARMCHAIRS

- DORELAN
- HOME SPIRIT
- MADE IN DESIGN

TRUNDLE BEDS

- BK ITALIA
- DORELAN
- HOME SPIRIT

BUNK & GUEST BEDS

- ADOVA
- DORELAN

DAYBEDS

- BK ITALIA
- DORELAN
- MADE IN DESIGN
- SOCA

CONVERTIBLE OTTOMANS

- BK ITALIA
- DORELAN
- HOME SPIRIT

CONVERTIBLE SOFAS



Agencia Europe baseia-se, antes de tudo, em valores humanos, com pessoas comprometidas que colocam a sua experiência e conhecimento ao serviço dos clientes para os acompanhar nos seus projetos com total transparência.

Como especialistas em planeamento de espaços, a Agencia Europe ouve e apoia oferecendo serviços de consultoria, soluções de design e mobiliário, bem como gestão e instalação de FF&E e OS&E.

Europe te escucha y te apoya ofreciendo servicios de consultoria, soluciones de design y OS&E, furniture solutions con FF&E and OS&E, e instalaciones e installation services.

Eco-Midscale / Upscale

Between -26% et -40% depending on the brand
On public prices excluding VAT

RSE

- Recycled materials ✓
- Programa de segunda vida ✓
- Eco conceção ✓

Services

- Feito sob medida ✓
- Modificação de produtos do catálogo ✓

Production: EUROPE

Certifications



Take back service
OUI

EcoVadis Score
TBC



**NOS PARTENAIRES
CANAPES ET
CONVERTIBLES**

Scandinavian
TENKSOM
Quinti Campeggi
esPatio

INNOVATION LIVING

*Bloomington

Kave Home

<https://www.agenciagroupe.com/>

Contact :

Thierry CAMPOLUNGI
thierry.campolunghi@agenciagroupe.com
Mobile : +33 6 26 30 99 99

Head office: 11 Rue Alphonse Mas 34500 BEZIERS

AGENCIAMEA
LA CONCEPTION DU BIEN-ÊTRE

BK convertible sofa



BK Group é uma empresa italiana especializada na produção de sofás e poltronas conversíveis há 60 anos..

Model BK 126



PROPERTIES

- Espuma HR 40 kg/m³
- Garantia de 2 anos
- Custos de entrega: a calcular
- Espessura: 15 cm



DIMENSIONS

- Dimensões totais: L191 x P90 cm
- Altura do assento: 44/45 cm

Score EcoVadis
En cours/100



- Possibilidade de tecido do cliente
- Cama pré-montada
- Capa removível
- Espuma resistente ao fogo

Model BK 127



PROPERTIES

- Espuma HR 40 kg/m³
- Garantia de 2 anos
- Custos de entrega: a calcular
- Espessura: 15 cm



DIMENSIONS

- Dimensões totais: L89 x P90 cm
- Altura do assento: 45 cm



- Sem correias
- Sem espaço de armazenamento



CONTACT

FRANCE/EUROPE

Sara Mandelli
sara@bkitalia.com
Tel: +39 03 63 48 971

BK convertible sofa



BK Group é uma empresa italiana especializada na produção de sofás e poltronas conversíveis há 60 anos..

Model BK 103



PROPERTIES

- Material padrão
- Espuma HR 40 kg/m³
- Garantia de 2 anos
- Espessura: 15 cm



DIMENSIONS

- Dimensões totais: L191 x P90 cm
- Altura do assento: 44/45 cm

Score EcoVadis
/100



- Possibilidade de tecido do cliente
- Cama pré-montada
- Capa removível
- Espuma resistente ao fogo

Model BK 108



PROPERTIES

- Espuma HR 40 kg/m³
- Garantia de 2 anos
- Espessura: 15 cm



DIMENSIONS

- Dimensões totais: L165 x P90 cm
- Altura do assento: 45 cm



- Sem correias
- Sem espaço de armazenamento



CONTACT

FRANCE/EUROPE

Sara Mandelli
sara@bkitalia.com
Tel: +39 03 63 48 971

BK convertible sofa



BK Group é uma empresa italiana especializada na produção de sofás e poltronas conversíveis há 60 anos..

Model BK 103



PROPERTIES

- Material padrão
- Espuma HR 40 kg/m³
- Garantia de 2 anos
- Espessura: 15 cm



DIMENSIONS

- Dimensões totais: L191 x P90 cm
- Altura do assento: 44/45 cm

Score EcoVadis
/100



- Possibilidade de tecido do cliente
- Cama pré-montada
- Capa removível
- Espuma resistente ao fogo

Model BK 108



PROPERTIES

- Espuma HR 40 kg/m³
- Garantia de 2 anos
- Espessura: 15 cm



DIMENSIONS

- Dimensões totais: L165 x P90 cm
- Altura do assento: 45 cm



- Sem correias
- Sem espaço de armazenamento



CONTACT

FRANCE/EUROPE

Sara Mandelli
sara@bkitalia.com
Tel: +39 03 63 48 971

BK convertible sofa



BK Group é uma empresa italiana especializada na produção de sofás e poltronas conversíveis há 60 anos..

Model BK 102



PROPERTIES

- Material padrão
- Espuma HR 40 kg/m³
- Garantia de 2 anos
- Custos de entrega: a calcular
- Espessura: 15 cm



DIMENSIONS

- Dimensões totais: L191 x P90 cm
- Altura do assento: 44/45 cm

Score EcoVadis
/100



- Possibilidade de tecido do cliente
- Cama pré-montada
- Capa removível
- Espuma resistente ao fogo

Model BK 118



PROPERTIES

- Espuma HR 40 kg/m³
- Garantia de 2 anos
- Custos de entrega: a calcular
- Espessura: 15 cm



DIMENSIONS

- Dimensões totais: L166 x P90 cm
- Altura do assento: 45 cm



- Sem correias
- Sem espaço de armazenamento



CONTACT

FRANCE/EUROPE

Sara Mandelli
sara@bkitalia.com
Tel: +39 03 63 48 971

BK convertible sofa



BK Group é uma empresa italiana especializada na produção de sofás e poltronas conversíveis há 60 anos..

Model BK 126 (special)



PROPERTIES

- Material padrão
- Espuma HR 40 kg/m³
- Garantia de 2 anos
- Custos de entrega: a calcular
- Espessura: 15 cm



DIMENSIONS

- Dimensões totais: L191 x P90 cm
- Altura do assento: 44/45 cm

Score EcoVadis
/100



- Customer fabric available
- Pre-made bed
- Removable cover
- Fire-retardant foam

Model BK 103 DECL

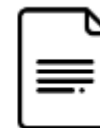

PROPERTIES

- Espuma HR 40 kg/m³
- Garantia de 2 anos
- Custos de entrega: a calcular
- Espessura: 15 cm



DIMENSIONS

- Dimensões totais: L166 x P90 cm
- Altura do assento: 45 cm



- No straps
- No storage space



CONTACT

FRANCE/EUROPE

Sara Mandelli
sara@bkitalia.com
Tel: +39 03 63 48 971

COLLINET convertible sofa



Desde 1887, a Collinet combina experiência e qualidade. O fabricante francês conta com o profissionalismo de cerca de 100 colaboradores para oferecer móveis de linhas simples, modernos e respeitadores dos estilos tradicionais..

EASY model



PROPERTIES

- Mecanismo de alta qualidade com dobras
- Densidade 25 kg/m³
- Espessura 13 cm
- Garantia legal de 2 anos



DIMENSIONS

- Profundidade: 100 cm
- Altura: 90 cm
- Altura do assento: 50 cm
- Dimensões totais quando aberto: 210 cm
- Opções de largura conforme o tamanho da cama em 190 cm (70-120-140-160-2x70 cm) e escolha dos apoios de braço

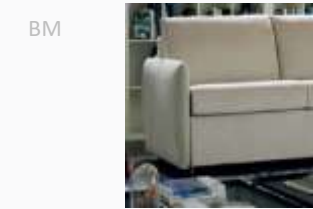

Score EcoVadis
30/100



- larguras de cama disponíveis (de poltrona a sofá de 3 lugares)
- Várias opções de braços (6 modelos)
- Capas removíveis
- Espuma retardante de fogo (opcional)
- Espaço para guardar almofadas



Plazo de entrega: 10 semanas



CONTACT

FRANCE/EUROPE

Virginie Collinet
virginie@collinet-sieges.fr
+33 (0)6 85 71 84 84

COLLINET convertible sofa



Desde 1887, a Collinet combina experiência e qualidade. O fabricante francês conta com o profissionalismo de cerca de 100 colaboradores para oferecer móveis de linhas simples, modernos e respeitadores dos estilos tradicionais..

SIBU model



PROPERTIES

- Mecanismo de alta qualidade com 2 dobras
- Densidade 25 kg/m³
- Espessura 12 cm
- Garantia legal de 2 anos



DIMENSIONS

- Profundidade: 105 cm
- Altura: 91 cm
- Altura do assento: 50 cm
- Dimensões quando aberto: 210 cm
- Opções de largura conforme a roupa de cama em 190 cm (70-120-140-160 cm)



1



3



4



Score EcoVadis
30/100

- 4 larguras de cama disponíveis (de poltrona a sofá de 3 lugares)
- Possibilidade de usar o tecido do cliente
- Capas removíveis
- Espuma retardante de fogo (opcional)
- Espaço para guardar almofadas



Plazo de entrega: 10 semanas



CONTACT

FRANCE/EUROPE

Virginie Collinet
virginie@collinet-sieges.fr
+33 (0)6 85 71 84 84

COLLINET convertible sofa



Desde 1887, a Collinet combina experiência e qualidade. O fabricante francês conta com o profissionalismo de cerca de 100 colaboradores para oferecer móveis de linhas simples, modernos e respeitadores dos estilos tradicionais..

Mélia model



PROPERTIES

- Mecanismo deslizante de alta qualidade
- Densidade 25 kg/m³
- Espessura 15 cm
- Garantia legal de 2 anos



DIMENSIONS

- Profundidade x comprimento: 208 x 92 cm
- Altura: 71 cm
- Altura do assento: 50 cm
- Cama superior: 195 x 85 cm e cama inferior: 185 x 80 cm



Score EcoVadis
30/100

- Cama extra com elevação automática
- Possibilidade de usar o tecido do cliente
- Capa removível
- Espuma retardante de fogo (opcional)
- Gaveta de armazenamento ou cama extra



CONTACT

FRANCE/EUROPE

Virginie Collinet
virginie@collinet-sieges.fr
+33 (0)6 85 71 84 84

DORELAN convertible sofa



dorelan®
dormire bene vivere meglio

A DORELAN, fabricante líder de roupa de cama e sofás conversíveis na Itália, foi fundada em Forli em 1968..

Patrick model



PROPERTIES

- Fácil de abrir inclinando o encosto graças a uma alça
- Densidade 45 kg/m³
- Espessura 15 cm (também disponível em 11 cm)
- Garantia de 24 meses



DIMENSIONS

- Dimensões totais*: a partir de L165 x P98 cm

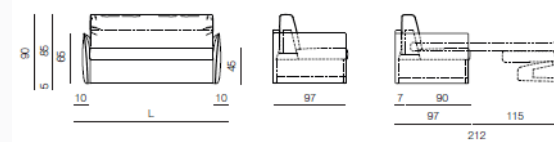

- Versões L: colchão Delight medindo 120/140/160 x 190 x h.11 cm com altura do assento do sofá-cama de 45 cm

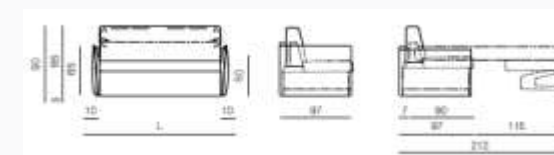

- Versão H: colchão Delight medindo 120/140/160 x 190 x h.15 cm com assento do sofá-cama a uma altura de 50 cm
- Todas as versões H estão disponíveis com um colchão Delight de 200 cm de comprimento (espessura 11 cm)

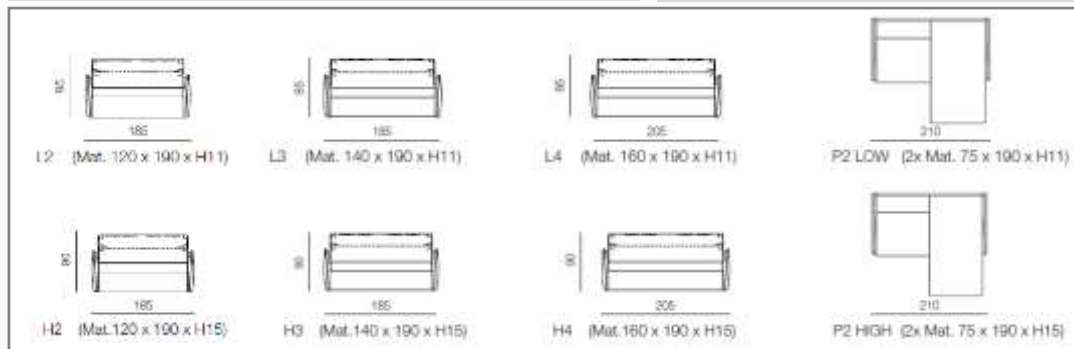

- Possibilidade de usar o tecido do cliente
- Espuma à prova de fogo 160 capas e cores disponíveis
- Capa removível
- Espaço de armazenamento
- A cama pode ser pré-montada sob pedido

Score EcoVadis

68/100



 **CONTACT**
FRANCE/EUROPE

Mirko de Lucia
m.delucia@dorelan.it
Tel: +33 7 72 36 58 84

As dimensões "totais" dos modelos Dorelan são fornecidas apenas para fins informativos. Pode ocorrer uma tolerância dimensional de 3 a 5% em todos os materiais, incluindo tecidos e estofados.

DORELAN convertible sofa



dorelan®
dormire bene vivere meglio

A DORELAN, fabricante líder de roupa de cama e sofás conversíveis na Itália, foi fundada em Forli em 1968..

Andrew P2 LOW or HIGH model



PROPERTIES

Fácil de abrir inclinando o encosto graças a uma alça

- Densidade 45 kg/m³
- Espessura 15 cm (também disponível em 11 cm)
- Garantia de 24 meses



DIMENSIONS

- Dimensões totais*: a partir de L195 x P98 cm

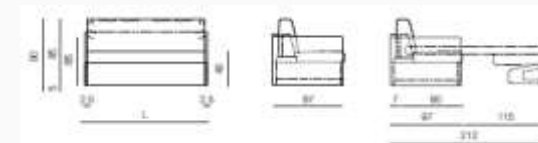
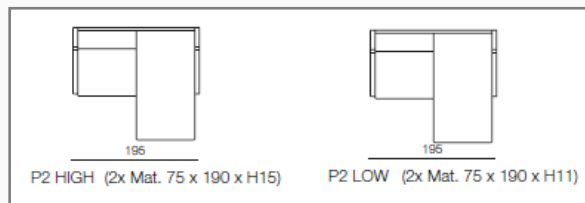

- Versões P2L: colchão Delight medindo 2x75x190 x h.11 cm com altura do assento do sofá-cama de 45 cm

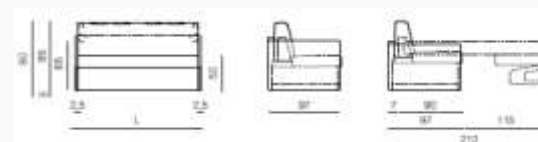

- Versão P2H: colchão Delight medindo 2x75x190 x h.15 cm com altura do assento do sofá-cama conversível de 50 cm
- Todas as versões H estão disponíveis com um colchão Delight de 200 cm de comprimento (espessura 11 cm)

As dimensões "totais" dos modelos Dorelan são fornecidas apenas para fins informativos. Pode ocorrer uma tolerância dimensional de 3 a 5% em todos os materiais, incluindo tecidos e estofados



- Possibilidade de usar o tecido do cliente
- Espuma à prova de fogo
- Capa removível
- Espaço de armazenamento
- A cama pode ser pré-montada sob pedido
- ☐ 160 fundas y colores disponibles

Score EcoVadis

68/100



CONTACT
FRANCE/EUROPE

Mirko de Lucia
m.delucia@dorelan.it
Tel: +33 7 72 36 58 84

DORELAN convertible sofa



dorelan®
dormire bene vivere meglio

A DORELAN, fabricante líder de roupa de cama e sofás conversíveis na Itália, foi fundada em Forli em 1968.

George model L



PROPERTIES

Fácil de abrir inclinando o encosto graças a uma alça

- Densidade 45 kg/m³
- Espessura 15 cm (também disponível em 11 cm)
- Garantia de 24 meses



DIMENSIONS

- Dimensões totais*: a partir de Largura 125 x Profundidade 98 cm

As fotos são meramente ilustrativas e não constituem um compromisso contratual. As versões L1, L1_90 e H1 são poltronas com uma única almofada de encosto e uma única almofada de assento

As dimensões "totais" dos modelos Dorelan são fornecidas apenas para fins informativos. Pode ocorrer uma tolerância dimensional de 3 a 5% em todos os materiais, incluindo tecidos e estofados

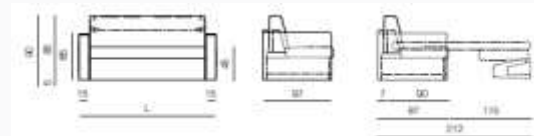

- Versões L: Colchão Delight medindo 75/90/100 x 190 x A.11 cm com altura do assento do sofá-cama de 45 cm.

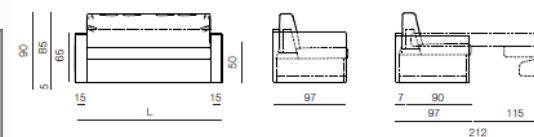

- Versão H: Colchão Delight medindo 75/100 x 190 x A.15 cm com altura do assento do sofá conversível de 50 cm.
- Todas as versões H estão disponíveis com um colchão Delight de 200 cm de comprimento (espessura de 11 cm)

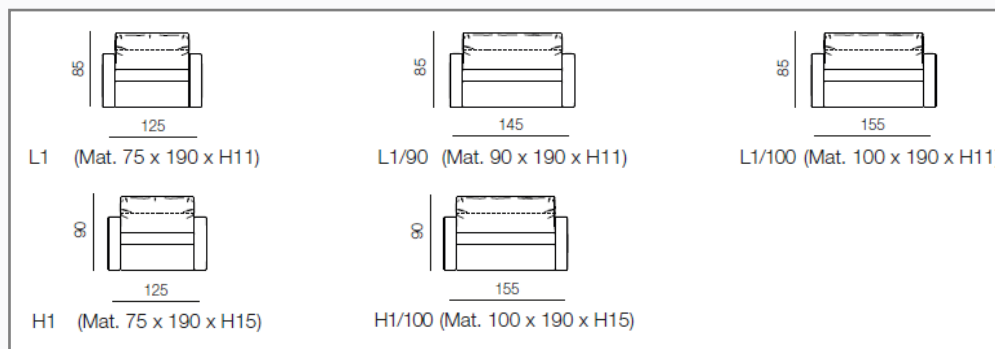

- Possibilidade de usar o tecido do cliente
- Espuma à prova de fogo
- Capa removível
- Espaço de armazenamento
- A cama pode ser pré-montada sob pedido
- ☐ 160 fundas y colores disponibles

Score EcoVadis
68/100



CONTACT
FRANCE/EUROPE

Mirko de Lucia
m.delucia@dorelan.it
Tel: +33 7 72 36 58 84

DORELAN convertible sofa



dorelan®
dormire bene vivere meglio

A DORELAN, fabricante líder de roupa de cama e sofás conversíveis na Itália, foi fundada em Forli em 1968..

Patrick model



PROPERTIES

Fácil de abrir inclinando o encosto graças a uma alça

- Densidade 45 kg/m³
- Espessura 15 cm (também disponível em 11 cm)
- Garantia de 24 meses



DIMENSIONS

- Dimensões totais*: a partir de L115 x P98 cm

As fotos são meramente ilustrativas e não constituem um compromisso contratual. As versões L1, L1_90 e H1 são poltronas com uma única almofada de encosto e uma única almofada de assento

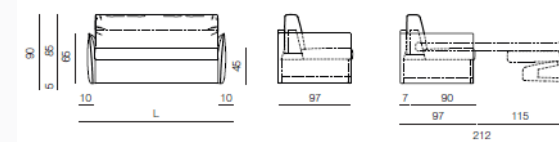

- Versões L: Colchão Delight medindo 75/90/100 x 190 x A.11 cm com altura do assento do sofá-cama de 45 cm

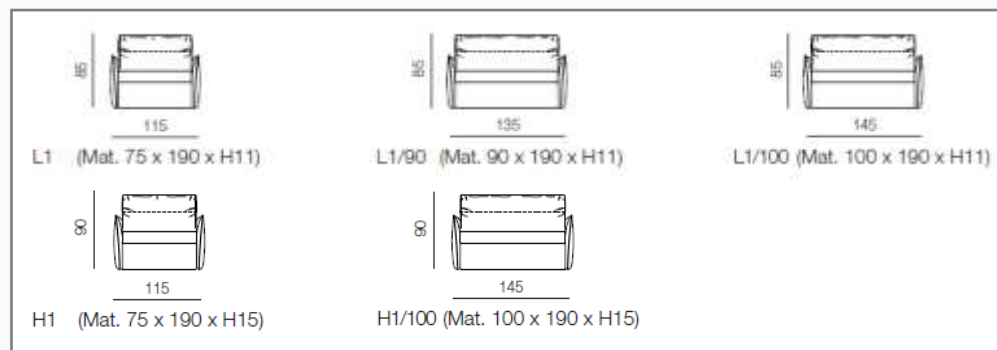
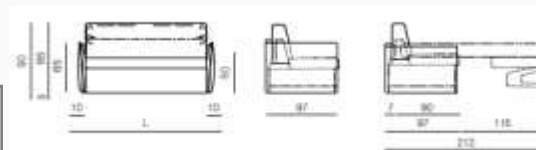

- Versão H: Colchão Delight medindo 75/100 x 190 x A.15 cm com altura do assento do sofá conversível de 50 cm.

Todas as versões H estão disponíveis com um colchão Delight de 200 cm de comprimento (espessura de 11 cm)



- Possibilidade de usar o 1 160 fundas y colores disponibles
- Espuma à prova de fogo
- Capa removível
- Espaço de armazenamento
- A cama pode ser pré-montada sob pedido

Score EcoVadis
68/100



CONTACT
FRANCE/EUROPE

Mirko de Lucia
m.delucia@dorelan.it
Tel: +33 7 72 36 58 84

As dimensões "totais" dos modelos Dorelan são fornecidas apenas para fins informativos. Pode ocorrer uma tolerância dimensional de 3 a 5% em todos os materiais, incluindo tecidos e estofados

Mousse du Nord convertible sofa



HOME SPIRIT

FRANCE



Fabricante francês de sofás fixos e conversíveis, poltronas e cadeiras. Produção integrada (design - carpintaria - corte e acolchoamento de espuma - montagem de sofás)

Mercure New Dedicace / Small model



PROPERTIES

Mecanismo de alta conforto com ripas ou grade (opcional), montado sobre corrediças
3 tamanhos de cama: L120 ou 140 ou 160 x P200 x A14
Espuma HR 35Klm3
5 anos de garantia"



DIMENSIONS

Dimensões totais: L152 ou 172 ou 192 x P97 cm
Altura do assento: 45 cm



Possibilidade de tecido do cliente Sem espuma antichama
Correias de assento
Assentos e encostos com capas removíveis



Score EcoVadis
49/100



Domi model



PROPERTIES

Mecanismo de alta conforto com ripas ou grade (opcional), montado sobre corrediças
3 tamanhos de cama: L120 ou 140 ou 160 x P200 x A14
Espuma HR 35Klm3
5 anos de garantia



DIMENSIONS

Dimensões totais: C 170 ou 190 ou 210 x P 97 cm
Altura do assento: 45 cm



CONTACT

FRANCE/EUROPE

Patric Lalarme
plalarme@homespirit.fr
T. 06 74 11 03 69

Website:
www.homespirit.fr

Disponível em tecido ou couro sintético.
Opção padrão M1 disponível.
Mais de 250 cores e materiais

Mousse du Nord convertible sofa



HOME SPIRIT

FRANCE



Fabricante francês de sofás fixos e conversíveis, poltronas e cadeiras. Produção integrada (design - carpintaria - corte e acolchoamento de espuma - montagem de sofás)

Bidart model



PROPERTIES

Mecanismo de alta conforto com ripas ou grade (opcional), montado sobre corredeiras
3 tamanhos de cama: L120 ou 140 ou 160 x P200 x A14
Espuma HR 35Klm3 + penas
5 anos de garantia



Cap Horn model



PROPERTIES

Mecanismo de alta conforto com ripas ou grade (opcional), montado sobre corredeiras
3 tamanhos de cama: L120 ou 140 ou 160 x P200 x A14
Espuma HR 35Klm3 + penas
5 anos de garantia



DIMENSIONS

Dimensões totais: L170 ou 190 ou 210 x P97 cm
Altura do assento: 45 cm



DIMENSIONS

Dimensões totais: C 156 ou 176 ou 196 x P 97 cm
Altura do assento: 45 cm



Possibilidade de tecido do cliente Sem espuma antichama
Correias de assento
Assentos e encostos com capas removíveis

Score EcoVadis
49/100



CONTACT

FRANCE/EUROPE

Patric Lalarme
plalarme@homespirit.fr
el. 06 74 11 03 69

Website:
www.homespirit.fr

Disponível em tecido ou couro sintético.
Opção padrão M1 disponível.
Mais de 250 cores e materiais

Mousse du Nord convertible sofa



HOME SPIRIT

FRANCE



Fabricante francês de sofás fixos e conversíveis, poltronas e cadeiras. Produção integrada (design - carpintaria - corte e acolchoamento de espuma - montagem de sofás)

Charles model



PROPERTIES

Mecanismo de alta conforto com ripas ou grade (opcional), montado sobre corredeiras
3 tamanhos de cama: L120 ou 140 ou 160 x P200 x A14
Espuma HR 35Klm3 + penas
5 anos de garantia



Sofa version



DIMENSIONS

Dimensões totais: L200 ou 220 ou 240 x P97 cm
Altura do assento: 45 cm



PROPERTIES

Mecanismo de alta conforto com ripas ou grade (opcional), montado sobre corredeiras
4 tamanhos de cama: L80 ou 120 ou 140 ou 160 x P200 x A14
Espuma HR 35Klm3 + penas
5 anos de garantia



DIMENSIONS

Dimensões totais: C 240/160 ou 280/160 ou 300/160 ou 320/160 x P 97 cm
Altura do assento: 45 cm

Reversible
left/right corner
version



Possibilidade de tecido do cliente Sem espuma antichama
Correias de assento
Assentos e encostos com capas removíveis

Score EcoVadis
49/100



CONTACT

FRANCE/EUROPE

Patric Lalarme
plalarme@homespirit.fr Tel.
06 74 11 03 69

Website:
www.homespirit.fr

Disponível em tecido ou couro sintético.
Opção padrão M1 disponível.
Mais de 250 cores e materiais

Convertible Sofa Mousse du Nord



Fabricante francês de sofás fixos e conversíveis, poltronas e cadeiras. Produção integrada (design - carpintaria - corte e acolchoamento de espuma - montagem de sofás)



HOME SPIRIT

FRANCE



Modele D



PROPERTIES

Mecanismo de grade de alto conforto, capas montadas sobre corrediças com colchão de 14 cm de espessura
Cama: L140 x P200 x A14
Espuma HR 35Kg/m³
Garantia de 5 anos

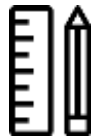

DIMENSIONS

C190 x P97 cm
Altura do assento: 45 cm



Tecido do cliente disponível
Alça de assento
Capa removível
Cama pré-mobiliada disponível mediante pedido (edredom/lençóis)

Modele Max 10 CM

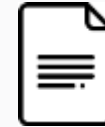

PROPERTIES

Mecanismo de ripas de 2 camadas com colchão de 10 cm de espessura
Cama: L133 x P185200 x A10
Espuma HR 35K/m³
Garantia de 5 anos



DIMENSIONS

C160 x P95 cm
Altura do assento: 43 cm



Sem espuma retardante de chama

Score EcoVadis

49/100



CONTACT

FRANCE/EUROPE

Patric Lalarme
plalarme@homespirit.fr
Tel. 06 74 11 03 69

ASTORE

LIGNE ROSET convertible sofa

Fundada em 1860, a Ligne Roset é uma empresa francesa especializada no fabrico de assentos e mobiliário. Eles podem fornecer soluções personalizadas. As suas fábricas são especializadas em estofamento, corte e colagem de espuma, corte de couro e tecido, e tratamento de superfícies de madeira..



ligne roset

CLAM model

PROPERTIES



Sistema de abertura fácil
Espessura: 17 cm
2 posições: sofá e cama



DIMENSIONS



Sofá: L242 x 105 x 89 cm
Altura do assento: 40 cm

Score EcoVadis
55/100



Capa removível por um profissional
Espuma resistente ao fogo



Sem espaço de armazenamento

Modelo: NÃO PERTURBE Área de dormir: 140 ou 160 Com ou sem mecanismo elétrico

PROPERTIES



Sistema de abertura fácil
Grosor: 14 cm
2 posiciones: sofá o cama



DIMENSIONS

Sistema de abertura fácil
Espessura: 14 cm
2 posições: sofá ou cama



CONTACT

FRANCE/EUROPE

Max Flageollet
mflageollet@roset.fr
+33 (0) 6 80 89 08 09

Made in Design convertible sofa

Made In Design é o líder europeu em vendas online de mobiliário, iluminação e decoração de design, oferecendo produtos das maiores marcas (Kartell, Hay, Foscarini, etc.) e designers (Starck, Dixon, etc.).

Chloé model - BOLIA



PROPERTIES

Sistema de abertura tecnológico
Densidade 35 kg/m³
Garantia de 24 meses
Entrega
Dimensões para dormir: 215 x 190 cm



DIMENSIONS

Dimensões totais: C214 x 116 x 86 cm
Altura do assento: 57 cm



Score EcoVadis
52/100



Assento de cintas
Cama pré-montada a pedido

Model: Up/Lift - PROSTORIA



PROPERTIES

Rebater a parte superior do encosto
Densidade 35 kg/m³
Garantia de 24 meses
Envio
Espessura: 14 cm



DIMENSIONS

Dimensões totais: C160 x 76 x 120
Altura do assento: 44 cm



Sem espaço de armazenamento
Sem espuma ignífuga
Sem tecido do cliente disponível
Capa não removível



CONTACT

FRANCE/EUROPE

LASSALLE Charlène
charlene.lassalle@madeindesign.com
+33 (0)4.38.12.34.75

Made in Design convertible sofa



made in design ●●●
I live design

Made In Design é o líder europeu em vendas online de mobiliário, iluminação e decoração de design, oferecendo produtos das maiores marcas (Kartell, Hay, Foscarini, etc.) e designers (Starck, Dixon, etc.).

Fade model - PROSTORIA



PROPERTIES

Sistema de abertura tecnológico
Densidade 35 kg/m³
Garantia de 24 meses
Entrega
Dimensões para dormir: 140 x 200 cm



DIMENSIONS

Dimensões totais: C246 x 108 x 76
Altura do assento: 40 cm



Score EcoVadis
52/100



Assento de cintas
Espuma ignífuga
Tecido do cliente disponível



A cama não pode ser pré-montada



CONTACT

FRANCE/EUROPE

LASSALLE Charlène
charlene.lassalle@madeindesign.com
+33 (0)4.38.12.34.75

Website:
www.madeindesign.com

Made in Design convertible sofa



made in design ●●●
I live design

Made In Design é o líder europeu em vendas online de mobiliário, iluminação e decoração de design, oferecendo produtos das maiores marcas (Kartell, Hay, Foscarini, etc.) e designers (Starck, Dixon, etc.).

Scandinavia model - BOLIA



PROPERTIES

Sistema de abertura tecnológico

Densidade 35 kg/m³

Garantia de 24 meses

Entrega

Dimensões para dormir: 200 x 218 cm



DIMENSIONS

Dimensões totais: C200 x 100 x 78 cm

Altura do assento: 45 cm

Score EcoVadis
52/100



Opção de pré-montar a cama



Sem espuma ignífuga
Sem espaço de
armazenamento
Sem tecido do cliente
Capa não removível



CONTACT

FRANCE/EUROPE

LASSALLE Charlène

charlene.lassalle@madeindesign.com

+33 (0)4.38.12.34.75

Pole Position, um fabricante francês de sofás desde 1991, reflete o artesanato francês. Cada sofá é feito à mão por artesãos qualificados usando métodos de fabricação industrial

Preços de catálogo -10% para Accor
Preços negociados por projeto

RSE	Product range
Materiais reciclados x	Sofás conversíveis, fixos, com capa removível, modulares, capas separadas disponíveis ✓
Programa Segunda Vida	✓ Customisation available ✓
Concepção ecológica	

Production: FRANCE

Sourcing: FRANCE & EUROPE

Return service:

Disponível sob consulta



EcoVadis Score: TBC



Contact:

Valentine Thevenin
Mobile: +33 6 33 31 11 87
valentine.thevenin@home-and-furniture.netplalarme@homespirit.fr

Range Eco - Midscale - Upscale



Pole Position, um fabricante francês de sofás desde 1991, reflete o artesanato francês. Cada sofá é feito à mão por artesãos qualificados usando métodos de fabricação industrial

Preços de catálogo -10% para Accor
Preços negociados por projeto

RSE
 Materiais reciclados x
 Programa Segunda Vida
 Concepção ecológica

Product range

Sofás conversíveis, fixos, com capa removível, modulares, capas separadas disponíveis

✓ Customisation available ✓

Production: FRANCE

Sourcing: FRANCE & EUROPE

Return service:
 Disponível sob consulta

Certifications:



EcoVadis Score: TBC

Contact:
 Valentine Thevenin
 Mobile: +33 6 33 31 11 87
 valentine.thevenin@home-and-furniture.netplalarme@homespirit.fr



Range Eco - Midscale - Upscale

AMALIA

137 cm coustige: 80x195 cm	197 cm coustige: 100x195 cm
137 cm coustige: 120x195 cm	197 cm coustige: 160x195 cm
	94 cm
217 cm coustige: 160x195 cm	

ASTRID

168 cm coustige: 80x195 cm	168 cm coustige: 100x195 cm
168 cm coustige: 100x195 cm	208 cm coustige: 160x195 cm
	94 cm
228 cm coustige: 160x195 cm	

Pole Position, um fabricante francês de sofás desde 1991, reflete o artesanato francês. Cada sofá é feito à mão por artesãos qualificados usando métodos de fabricação industrial

Preços de catálogo -10% para Accor
Preços negociados por projeto

Range Eco - Midscale - Upscale

- RSE
- Materiais reciclados x
- Programa Segunda Vida
- Concepção ecológica

- Product range
- Sofás conversíveis, fixos, com capa removível, modulares, capas separadas disponíveis
- Customisation available



Production: FRANCE
Sourcing: FRANCE & EUROPE
Return service: Disponível sob consulta

Certifications:

EcoVadis Score: TBC

Contact:
 Valentine Thevenin
 Mobile: +33 6 33 31 11 87
 valentine.thevenin@home-and-furniture.netplalarme@homespirit.fr



Pole Position, um fabricante francês de sofás desde 1991, reflete o artesanato francês. Cada sofá é feito à mão por artesãos qualificados usando métodos de fabricação industrial

Preços de catálogo -10% para Accor
Preços negociados por projeto

Range Eco - Midscale - Upscale

- RSE
- Materiais reciclados x
- Programa Segunda Vida
- Concepção ecológica
- ✓ Customisation available

Product range

Sofás conversíveis, fixos, com capa removível, modulares, capas separadas disponíveis

Certifications:



EcoVadis Score: TBC

Production: FRANCE

Sourcing: FRANCE & EUROPE

Return service:

Disponível sob consulta

Contact:

Valentine Thevenin
 Mobile: +33 6 33 31 11 87
 valentine.thevenin@home-and-furniture.netplalarme@homespirit.fr



SILTEC convertible sofa



Siltec

A Siltec, fundada há quase 40 anos, é um distribuidor de mobiliário de interior, para conferências, escritório e exterior. A Siltec opera em França e no estrangeiro



ASLAK model

PROPERTIES

Garantia de 10 anos
Opções de colchão: molas ou molas macias (mais suave)
Capa de cama incluída
Adequado para dormir diariamente



DIMENSIONS

Dimensões totais: C200 x 112 cm
Altura do assento: 37 cm



Capa removível (somente ASLAK)
Espuma ignífuga

Cama feita sob pedido (somente ASLAK)



CUBE model

PROPERTIES

Sistema de abertura fácil
Garantia de 2 anos
Custos de entrega
Possibilidade de dormir diariamente



DIMENSIONS

Dimensões totais: C140 x 200
Altura do assento: 66 cm



Tecido do cliente não é possível



CONTACT

FRANCE/EUROPE

Célia Chabin

cchabin@siltec-mobilier.com

Clément Bousquet

cbousquet@siltec-mobilier.com

01.42.66.09.13

SILTEC convertible sofa



Siltec

A Siltec, fundada há quase 40 anos, é um distribuidor de mobiliário de interior, para conferências, escritório e exterior.
A Siltec opera em França e no estrangeiro



OSVALD model

PROPERTIES

Garantia de 2 anos
Adequado para dormir diariamente



DIMENSIONS

Dimensões totais: C160 x 200 cm
Altura do assento: 43 cm



Capa removível
Espuma ignífuga



ZEAL model

PROPERTIES

Sistema de abertura fácil
Garantia de 2 anos
Custos de entrega



DIMENSIONS

Dimensões totais: C70 x 200
Altura do assento: 61 cm



Não há tecido personalizado
disponível



CONTACT

FRANCE/EUROPE/WORLD

Célia Chabin

chabin@siltec-mobilier.com

Clément Bousquet

cbousquet@siltec-mobilier.com

01.42.66.09.13

SILTEC convertible sofa



Siltec

A Siltec, fundada há quase 40 anos, é um distribuidor de mobiliário de interior, para conferências, escritório e exterior. A Siltec opera em França e no estrangeiro

OLDSCHOOL model



PROPERTIES

Sistema de abertura fácil
Garantia de 10 anos
Custos de entrega



DIMENSIONS

Dimensões totais: C115 x 220 cm
Altura do assento: 38 cm



Capa removível
Espuma ignífuga



SPLITBACK model

PROPERTIES

Sistema de abertura fácil
Garantia de 10 anos
Custos de entrega



DIMENSIONS

Dimensões totais: C70 x 200
Altura do assento: 61 cm



Não há tecido personalizado disponível



CONTACT

FRANCE/EUROPE

Célia Chabin

cchabin@siltec-mobilier.com

Clément Bousquet

cbousquet@siltec-mobilier.com

01.42.66.09.13

CONVERTIBLE ARMCHAIRS



DORELAN convertible armchair



dorelan®
dormire bene vivere meglio

A DORELAN, líder italiana no setor de colchões e sofás conversíveis, foi fundada em Forli em 1968

Andrew model



PROPERTIES

- Fácil de abrir inclinando o encosto graças a uma alça
- Densidade 45 kg/m³
- Espessura 11 cm (também disponível em 15 cm)
- Garantia de 24 meses



DIMENSIONS

- Dimensões totais*: de C 100 x P 98 cm

As fotos são meramente ilustrativas e não constituem um compromisso contratual.

As versões L1, L1_90 e H1 são poltronas com uma única almofada de encosto e uma única almofada de assento.

As dimensões gerais dos modelos Dorelan são fornecidas apenas para fins informativos. Pode ser observada uma tolerância dimensional de 3 a 5% para todos os materiais que compreendem têxteis e estofos.

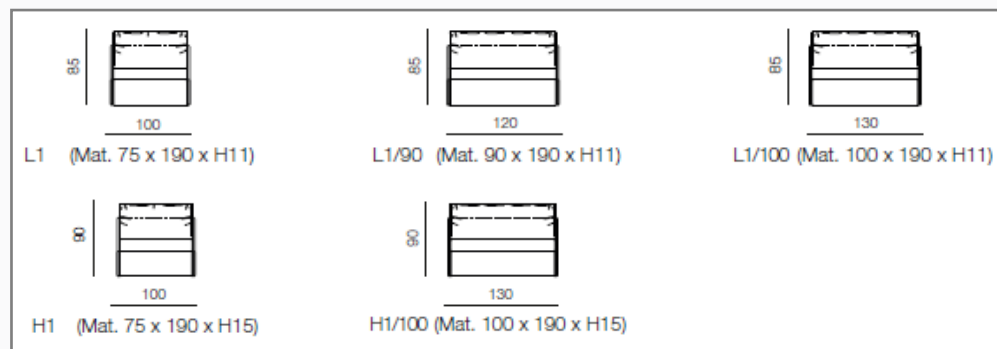

- Tecido do cliente disponível
- Espuma ignífuga
- Capas removíveis
- Espaço de armazenamento
- Cama pré-montada a pedido

- ☐ 160 tecidos e cores de estofamento disponíveis

Score EcoVadis
68/100

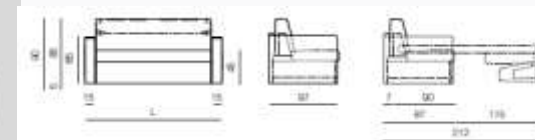

- Versões L: Colchão Delight medindo 75/90/100 x 190 x a.11 cm com altura do assento do sofá-cama de 45 cm

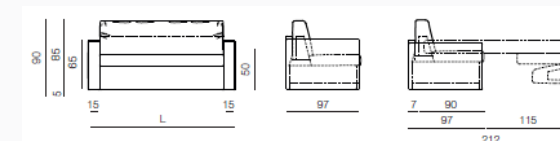

- Versão H: Colchão Delight medindo 75/100 x 190 x a.15 cm com assento de sofá conversível a uma altura de 50 cm. Todas as versões H estão disponíveis com um colchão Delight de 200 cm de comprimento (espessura de 11 cm)

CONTACT
FRANCE/EUROPE

Mirko de Lucia
m.delucia@dorelan.it
Tel: +33 7 72 36 58 84

Mousse du Nord convertible armchair



HOME SPIRIT

FRANCE



Fabricante francês de sofás fixos e conversíveis, poltronas e cadeiras. Produção integrada (design - carpintaria - corte e acolchoamento de espuma - montagem de sofás)

CASA convertible armchair model



PROPERTIES

Sistema de abertura mecânico em ziguezague
Espuma HR 35Klm3
Garantia de 5 anos
Espessura: 10 cm



Casa chauffeuse / Element
83 x 88 x 84 cm



- Possibilidade de tecido do cliente
- Correias de assento
- Assentos e encostos com capas removíveis



PROPERTIES

Mecanismo de grelha de alto conforto c
(opcional), montado sobre corrediças
Espuma HR 35Klm3
Garantia de 5 anos
Espessura: 14 cm



DIMENSIONS

Dimensões totais: C125 x P97 cm
Altura do assento: 45 cm



DIMENSIONS

Dimensões totais: C112 x P 97
Altura do assento: 45 cm

Score EcoVadis

49/100



CONTACT

FRANCE/EUROPE

Patric Lalarme
plalarme@homespirit.fr
T. 06 74 11 03 69

Website:

www.homespirit.fr

Disponível em tecido ou imitação de couro.
Padrão M1 disponível.
Mais de 250 cores e materiais.

Mousse du Nord convertible armchair



HOME SPIRIT

FRANCE



French manufacturer of fixed and convertible sofas, armchairs and chairs. Integrated production (design - carpentry - foam cutting and cushioning - sofa assembly)

Model: Bidart



PROPERTIES

Mecanismo de ripas ou grelha de alto conforto (opcional), montado sobre corrediças
Área de dormir: C 80 x P 200 x A 14
Espuma HR 35Klm3 + penas
Garantia de 5 anos



DIMENSIONS

Dimensões totais: C130 x P 97
Altura do assento: 45 cm

Model: Cassis



PROPERTIES

Mecanismo de ripas ou grelha de alto conforto (à sua escolha), montado sobre corrediças
Dimensões da área de dormir: C 80 x P 200 x A 14
Espuma HR 35Klm3 + penas
Garantia de 5 anos



DIMENSIONS

Dimensões totais: C118 x P97 cm
Altura do assento: 45 cm



Score EcoVadis

49/100

- Possibilidade de tecido do cliente
- Correias de assento
- Assentos e encostos com capas removíveis



Website:

www.homespirit.fr

Disponível em tecido ou imitação de couro.

Padrão M1 disponível.

 **CONTACT**

FRANCE/EUROPE

Patric Lalarme
plalarme@homespirit.fr Tel.
06 74 11 03 69

Mousse du Nord convertible armchair



HOME SPIRIT

FRANCE



French manufacturer of fixed and convertible sofas, armchairs and chairs. Integrated production (design - carpentry - foam cutting and cushioning - sofa assembly)

Small model



PROPERTIES

Mecanismo de ripas ou grelha de alto conforto (opcional), montado sobre corrediças
Área de dormir: C 80 x P 200 x A 14
Espuma HR 35Klm3
Garantia de 5 anos



DIMENSIONS

Dimensões totais: C113 x P 97
Altura do assento: 45 cm

Domi model



FEATURES

Mecanismo de ripas ou grelha de alto conforto (opcional), montado sobre corrediças
Área de dormir: C 80 x P 200 x A 14
Espuma HR 35Klm3
Garantia de 5 anos



DIMENSIONS

Total: C130 x P 97
Altura do assento: 45 cm



Score EcoVadis

49/100

- Possibilidade de tecido do cliente
- Correias de assento
- Assentos e encostos com capas removíveis



Website:

www.homespirit.fr

Disponível em tecido ou imitação de couro.

Padrão M1 disponível.



CONTACT

FRANCE/EUROPE

Patric Lalarme
plalarme@homespirit.fr
Tel. 06 74 11 03 69

Mousse du Nord convertible armchair



HOME SPIRIT

FRANCE



French manufacturer of fixed or convertible sofas, armchairs and chairs. Integrated production (creation - carpentry - foam cutting and cushioning - sofa assembly)

Lounge chair lord Ibis model



PROPERTIES

Espuma HR 35Klm3
Garantia de 5 anos
Espessura 10 cm



DIMENSIONS

- L90 x D92 cm
• Altura do assento: 49 cm



- Possibilidade de tecido do cliente
- Correias de assento
- Assentos e encostos com capas removíveis



- No customer tissue



CONTACT

FRANCE/EUROPE

Patric Lalarme
plalarme@homespirit.fr
Tel. 06 74 11 03 69

ASTORE

Convertible armchairs Made in Design



made in design ●●●

I live design

Made In Design é o líder europeu em vendas online de móveis, iluminação e decoração de design, oferecendo produtos das maiores marcas (Kartell, Hay, Foscarini, etc.) e designers (Starck, Dixon, etc.).

Silver model – SOFTLINE DK



PROPERTIES

Garantia de 24 meses
Envio
Dimensões para dormir: 56 x 196 cm



DIMENSIONS

Dimensões totais: C100 x 86 x 73
Altura do assento: 38 cm



Score EcoVadis
49/100



Espuma ignífuga

Up/lift model - PROSTORIA



PROPERTIES

Rebater a parte superior do encosto
Densidade 35 kg/m³
Garantia de 24 meses
Envio



DIMENSIONS

Dimensões totais: C80 x 76 x 120
Altura do assento: 44 cm



- Sem espaço de arrumação
- Não há tecido do cliente disponível
- Capa não removível
- Sem opção de fazer a cama com antecedência



CONTACT

FRANCE/EUROPE

LASSALLE Charlène
charlene.lassalle@madeindesign.com
+33 (0)4.38.12.34.75

TRUNDLE BEDS



BK pull-out bed



BK Group é uma empresa italiana que se especializou na produção de sofás e poltronas conversíveis há 60 anos

Model BK 115



PROPERTIES

Espuma HR 40 kg/m³
Garantia de 2 anos
Custos de entrega: a calcular
Espessura: 15 cm



DIMENSIONS

Dimensões totais: C240 x P90 cm
Altura do assento: 47 cm



Score EcoVadis
43/100



- Tecido do cliente disponível
- Cama pronta
- Capas removíveis
- Espuma retardadora de chamas



- Sem alças
- Sem espaço de armazenamento



CONTACT
FRANCE/EUROPE

Sara Mandelli
sara@bkitalia.com
Tel: +39 03 63 48 971

DORELAN pull-out beds



dorelan®
dormire bene vivere meglio

A DORELAN, fabricante líder de roupa de cama e sofás-cama da Itália, foi fundada em Forli em 1968.

ROSY model



PROPERTIES

- Densidade 45 kg/m³
- Espessura 15 cm
- Garantia de 24 meses
- Sistema Easyflip®: fácil inversão do assento
- Sistema Extra: cama auxiliar extraível
- Sistema Space: gaveta que economiza espaço



DIMENSIONS

- Dimensões totais*: de C 205xA 100 cm
- Altura do assento: 45 cm

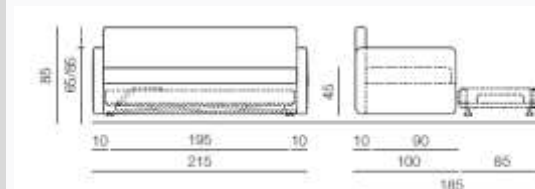
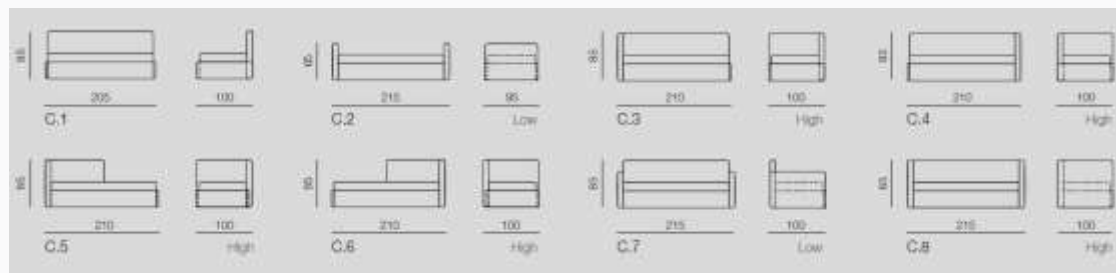

- Tecido do cliente disponível
- Espuma retardadora de chamas
- Capa removível
- Cama pode ser pré-montada a pedido
- Sistema Easyflip®
- 160 revestimentos e cores disponíveis
- Sistema Extra
- Sistema Space



- Sem alças

Score EcoVadis
68/100



 **CONTACT**
FRANCE/EUROPE

Mirko de Lucia
m.delucia@dorelan.it
Tel: +33 7 72 36 58 84

*As dimensões gerais dos modelos Dorelan são fornecidas apenas para fins informativos. Uma tolerância dimensional de 3 a 5% pode ser observada para todos os materiais que compreendem têxteis e estofamento

DORELAN pull-out beds



dorelan®
dormire bene vivere meglio

A DORELAN, fabricante líder de roupa de cama e sofás-cama da Itália, foi fundada em Forli em 1968.

CHERIE S model



PROPERTIES

- Density 45 kg/m³
- Thickness 15 cm
- 24-month warranty
- Easyflip® system: easy seat reversal
- Extra system: pull-out trundle bed
- Space system: space-saving drawer

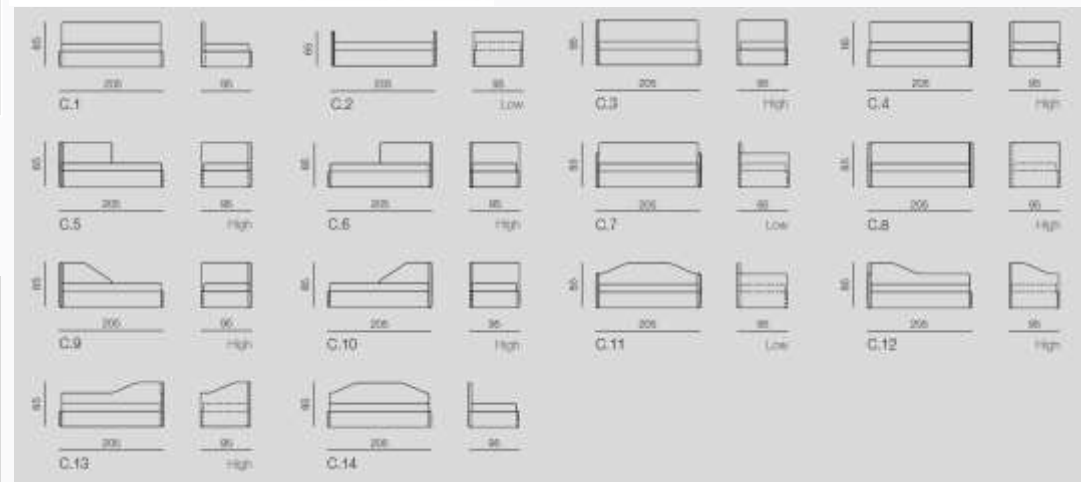
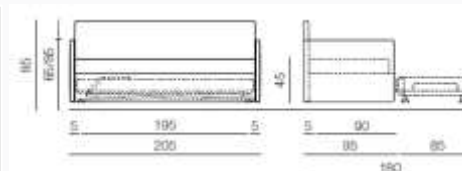

DIMENSIONS

- Overall dimensions*: from L205 x D95 cm
- Seat height: 45 cm

*As dimensões gerais dos modelos Dorelan são fornecidas apenas para fins informativos. Uma tolerância dimensional de 3 a 5% pode ser observada para todos os materiais que compreendem têxteis e estofamento



- Tecido do cliente disponível
- Espuma retardadora de chamas
- Capa removível
- Cama pode ser pré-montada a pedido
- Sistema Easyflip®
- 160 revestimentos e cores disponíveis
- Sistema Extra
- Sistema Space
- Sem alças



Score EcoVadis
68/100



 **CONTACT**
FRANCE/EUROPE

Mirko de Lucia
m.delucia@dorelan.it
Tel: +33 7 72 36 58 84

DORELAN pull-out bed



dorelan®
dormire bene vivere meglio

A DORELAN, fabricante líder de roupa de cama e sofás-cama da Itália, foi fundada em Forli em 1968.

DOROTHY model



PROPERTIES

- Density 45 kg/m³
- Thickness 15cm
- 24-month warranty
- Easyflip® system: easy seat reversal
- Space system: space-saving drawer
- Extra system: pull-out trundle bed



DIMENSIONS

- Overall dimensions*: from L 205 x D 100 cm
- Seat height: 42 cm

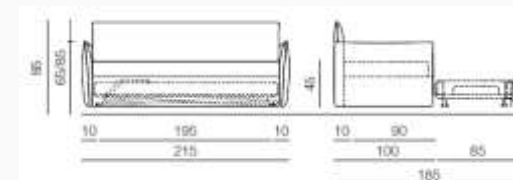
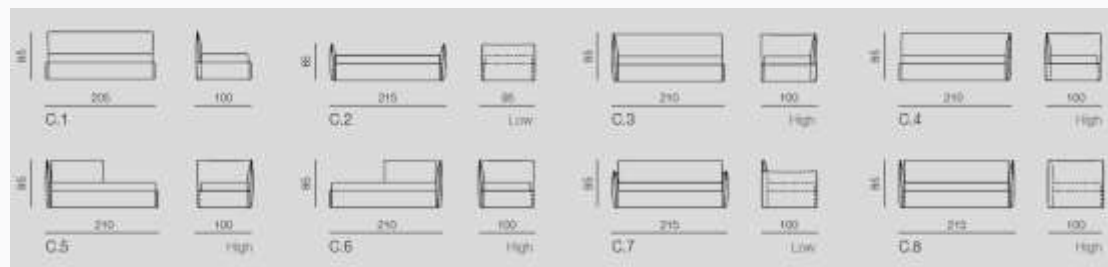

- Tecido do cliente disponível
- Espuma retardadora de chamas
- Capa removível
- Cama pode ser pré-montada a pedido
- Sistema Easyflip®



- Sem alças

- 160 revestimentos e cores disponíveis
- Sistema Extra
- Sistema Space

Score EcoVadis
68/100



*As dimensões gerais dos modelos Dorelan são fornecidas apenas para fins informativos. Uma tolerância dimensional de 3 a 5% pode ser observada para todos os materiais que compreendem têxteis e estofamento

 **CONTACT**
FRANCE/EUROPE

Mirko de Lucia
m.delucia@dorelan.it
Tel: +33 7 72 36 58 84

DORELAN pull-out bed



dorelan®
dormire bene vivere meglio

A DORELAN, fabricante líder de roupa de cama e sofás-cama da Itália, foi fundada em Forli em 1968.

DOROTHY model



PROPERTIES

- Densidade 45 kg/m³
- Espessura 15 cm
- Garantia de 24 meses



DIMENSIONS

- Dimensões totais: C 210 x P 100 cm
- Altura do assento: 42 cm



- Tecido do cliente disponível
- Espuma retardadora de chamas
- Capa removível
- Cama pode ser pré-montada a pedido



- Sem alças
- Sem espaço de arrumação

Score EcoVadis
68/100



 **CONTACT**
FRANCE/EUROPE

Mirko de Lucia
m.delucia@dorelan.it
Tel: +33 7 72 36 58 84

*As dimensões gerais dos modelos Dorelan são fornecidas apenas para fins informativos. Uma tolerância dimensional de 3 a 5% pode ser observada para todos os materiais que compreendem têxteis e estofamento

Mousse du Nord pull-out bed



HOME SPIRIT

FRANCE



Fabricante francês de sofás fixos e conversíveis, poltronas e cadeiras. Produção integrada (design - carpintaria - corte e estofamento de espuma - montagem de sofás)

Model: CASA GIGOGNE



PROPERTIES

- Sistema de abertura/tecnologia CAMA GAVETA
- Área de dormir 2 colchões: 80 x 190 e 80 x 185 cm espuma HR 35Klm3
- Espessura 12 cm
- 5 anos de garantia



DIMENSIONS

- Dimensões totais: C219 x P95 cm
- Altura do assento: 50 cm



Score EcoVadis
49/100



- Tecido do cliente possível
- Capas 100% removíveis



- Sem cama pré-montada
- Sem espuma à prova de fogo
- Sem assento com correias
- Sem espaço de armazenamento



CONTACT

FRANCE/EUROPE

Patric Lalarme
plalarme@homespirit.fr
Tel. 06 74 11 03 69

Website:
www.homespirit.fr

Disponível em tecido ou imitação de couro. Opção padrão M1 disponível. Mais de 250 cores e materiais

BUNK BEDS AND GUEST BEDS



A Hotelys é uma subsidiária da Ouest Bedding, dedicada exclusivamente a estabelecimentos hoteleiros, com a mais vasta gama de camas do mercado. A Hotelys também oferece produtos para todos os tipos de estabelecimentos, domínio de todas as tecnologias do mercado, uma escolha incomparável de acabamentos/modelos e uma organização totalmente dedicada à indústria hoteleira.

Kangourou model



PROPERTIES

- Chaise longue com cama extra integrada com encosto
- Colchão de espuma de poliuretano HD 35kg/m3
- Garantia de 5 anos (colchão), 2 anos (mecânica)

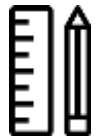

DIMENSIONS

ALTURA 36 PROFUNDIDADE 90 LARGURA 200



Score EcoVadis

66/100



- Grande variedade de cores
- Cama pronta
- Revestimento retardador de chamas



CONTACT

FRANCE/EUROPE

Gaetane le Dru

gledru@adova-group.com

Tel (0)6 03 85 95 73

ASTORE

A Hotelys é uma subsidiária da Ovest Bedding, dedicada exclusivamente a estabelecimentos hoteleiros, com a mais vasta gama de camas do mercado. A Hotelys também oferece produtos para todos os tipos de estabelecimentos, domínio de todas as tecnologias do mercado, uma escolha incomparável de acabamentos/modelos e uma organização totalmente dedicada à indústria hoteleira.

Gigogne model:



PROPERTIES

- Cama auxiliar que pode ser posicionada sob a cama principal
- Colchão de espuma de poliuretano HD 35kg/m³
- Garantia de 5 anos (colchão), 2 anos (mecânica)



DIMENSIONS

- C198x LARGURA 80 x ALTURA 36

Score EcoVadis

66/100



Armazenamento sem bagunça
Armazenamento rápido
Colchão com tecido retardador de fogo



CONTACT

FRANCE/EUROPE

Gaetane le Dru
gledru@adova-group.com

Tel (0)6 03 85 95 73

A STORE

ADOVA extra beds (*Hotelys*)



ADOVA
GROUP

A Hotelys é uma subsidiária da Ouest Bedding, dedicada exclusivamente a estabelecimentos hoteleiros, com a mais vasta gama de camas do mercado. A Hotelys também oferece produtos para todos os tipos de estabelecimentos, domínio de todas as tecnologias do mercado, uma escolha incomparável de acabamentos/modelos e uma organização totalmente dedicada à indústria hoteleira.

Versatile bed model



PROPERTIES

- Cama extra vertical sobre rodízios
- Colchão de espuma de poliuretano HD 35kg/m³
- Garantia de 5 anos (colchão), 2 anos (peças mecânicas)



DIMENSIONS

- Dimensões totais: 80X190, desdobrado
ALTURA 36 CM



Score EcoVadis
66/100



- Capa de armazenamento
- Cama pronta
- Revestimento à prova de fogo



CONTACT

FRANCE/EUROPE

Gaetane le Dru
gledru@adova-group.com
Tel (0)6 03 85 95 73

ADOVA extra beds (*Hotelys*)



ADOVA
GROUP

A Hotelys é uma subsidiária da Ouest Bedding, dedicada exclusivamente a estabelecimentos hoteleiros, com a mais vasta gama de camas do mercado. A Hotelys também oferece produtos para todos os tipos de estabelecimentos, domínio de todas as tecnologias do mercado, uma escolha incomparável de acabamentos/modelos e uma organização totalmente dedicada à indústria hoteleira.

Baby bed model



PROPERTIES

- Berço
- Colchão de espuma de poliuretano, altura 14 cm
- Garantia de 5 anos (colchão), 2 anos (peças mecânicas)



DIMENSIONS

- Dimensões desdobrado: 120 cm de comprimento x 60 cm de largura x 77 cm de altura



Pliage facile

Zoom sur :



Charnière d'angle



Charnière de pliage



Roues avec frein

Score EcoVadis

66/100



- Conforto excepcional para bebés
- Revestimento resistente ao fogo



CONTACT

FRANCE/EUROPE

Gaetane le Dru

gledru@adova-group.com

Tel (0)6 03 85 95 73

A DORELAN, fabricante líder de roupa de cama e sofás-cama da Itália, foi fundada em Forli em 1968

ASTUCIO model



PROPERTIES

- Espessura do colchão 15cm
- Garantia de 24 meses
- Densidade 45 kg/m³
- Sistema Easyflip®:
- Fácil inversão do assento



DIMENSIONS

- 222 x 99 x 100/156 cm aprox.
- Altura do assento: H47 cm aprox

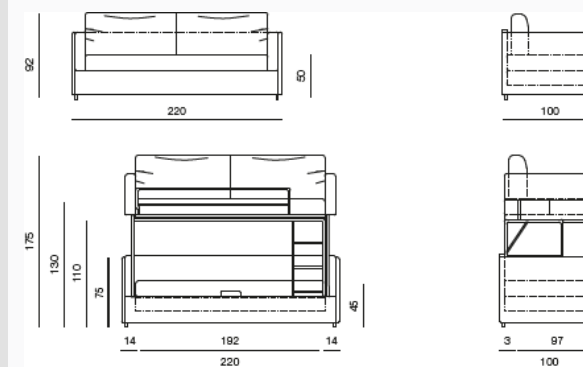

Score EcoVadis

68/100



*O tamanho "geral" dos modelos Dorelan é apenas para informação. Uma tolerância dimensional de 3 a 5% para todos os materiais que compreendem têxteis e materiais estofados pode ser observada.



- Tecido do cliente possível
- Removível
- Sistema Easyflip®
- 160 revestimentos e cores disponíveis



- Sem alça
- Sem cama pré-montada
- Sem espaço de armazenamento

CONTACT FRANCE/EUROPE

Fabrice MORAND
f.morand@dorelanfrance.fr
Tel: +33 7 72 36 58 84

DORELAN guest beds



dorelan®
dormire bene vivere meglio

A DORELAN, fabricante líder de roupa de cama e sofás-cama da Itália, foi fundada em Forli em 1968

Vertical guest bed model



PROPERTIES

- Estrado de ripas com cintas verticais
- Opção de capa de sommier com pregas



DIMENSIONS

Dimensões totais: 92 x 210 cm



Score EcoVadis

68/100



*O tamanho "geral" dos modelos Dorelan é apenas para informação. Uma tolerância dimensional de 3 a 5% para todos os materiais que compreendem têxteis e materiais estofados pode ser observada.

- Tecido do cliente possível
- Removível
- 160 revestimentos e cores disponíveis



- Sem alça
- Sem cama pré-montada
- Sem espaço de armazenamento



CONTACT

FRANCE/EUROPE

Mirko de Lucia
m.delucia@dorelan.it
Tel: +33 7 72 36 58 84

A DORELAN, fabricante líder de roupa de cama e sofás-cama da Itália, foi fundada em Forli em 1968

CHERIE F7 BUNK model



PROPERTIES

- Espessura 15cm
- Garantia de 24 meses
- Densidade 45 kg/m3



DIMENSIONS

210 x 100cm
Altura do assento: 45cm



*O tamanho "geral" dos modelos Dorelan é apenas para informação. Uma tolerância dimensional de 3 a 5% para todos os materiais que compreendem têxteis e materiais estofados pode ser observada.

Score EcoVadis
68/100



- Tecido do cliente possível
- Removível



- Sem alça
- Sem cama pré-montada
- Sem espaço de armazenamento

 **CONTACT**
FRANCE/EUROPE

Fabrice MORAND
f.morand@dorelanfrance.fr
Tel: +33 7 72 36 58 84

DAYBEDS



BK Group é uma empresa italiana que tem se especializado na produção de sofás e poltronas conversíveis há 60 anos.

BK 113 model



PROPERTIES

- Espuma HR 40 kg/m³
- Garantia de 2 anos
- Densidade: 40 kg/m³
- Espessura: 15 cm



DIMENSIONS

- L202 x P90 cm
- Altura do assento: 47 cm

Score EcoVadis
43/100



- Tela del cliente disponible
- Cama preinstalada
- Espuma ignífuga



Sem correia



CONTACT

FRANCE/EUROPE

Sara Mandelli
sara@bkitalia.com
Tel: + 39 03 63 48 971

ASTORE

DORELAN, o principal fabricante italiano de roupa de cama e sofás conversíveis, foi fundado em Forlì em 1968.

Cherie S UP model



PROPERTIES

- Densidade: 45 kg/m³
- Espessura: 15 ou 20 cm
- Garantia de 4 meses
- Sistema Easyflip®: fácil de virar o assento

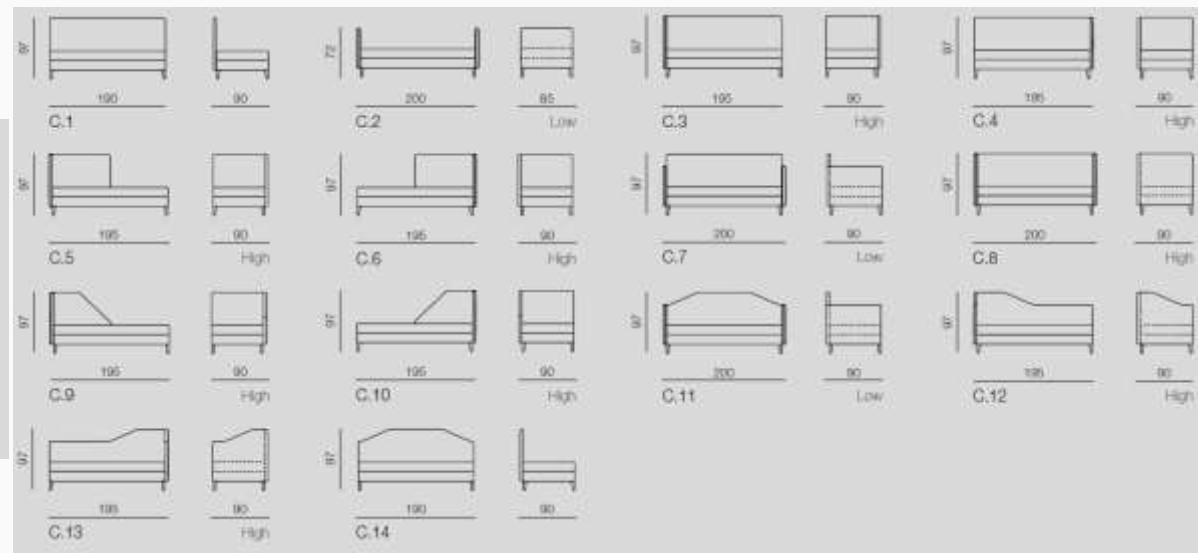

DIMENSIONS

- A partir de L190 x P90 cm
- Altura do assento: 46 cm

Score EcoVadis

68/100



- Tecido do cliente disponível
- Espuma retardante de fogo
- Tecido do cliente disponível
- Espuma retardante de fogo
- 160 revestimentos e cores disponíveis



- Sem correia
- Sem espaço de armazenamento



CONTACT

FRANCE/EUROPE

Fabrice MORAND
f.morand@dorelanfrance.fr
 Tel: +33 7 72 36 58 84

DORELAN, o principal fabricante italiano de roupa de cama e sofás conversíveis, foi fundado em Forlì em 1968

Cherie M10 UP model



PROPERTIES

- Density 45 Kg/M3
- Thickness 15 or 20 cm
- 24-month guarantee
- Easyflip® system: easy turning of the seat



DIMENSIONS

- L 200x D95 cm
- Seat height: 42cm

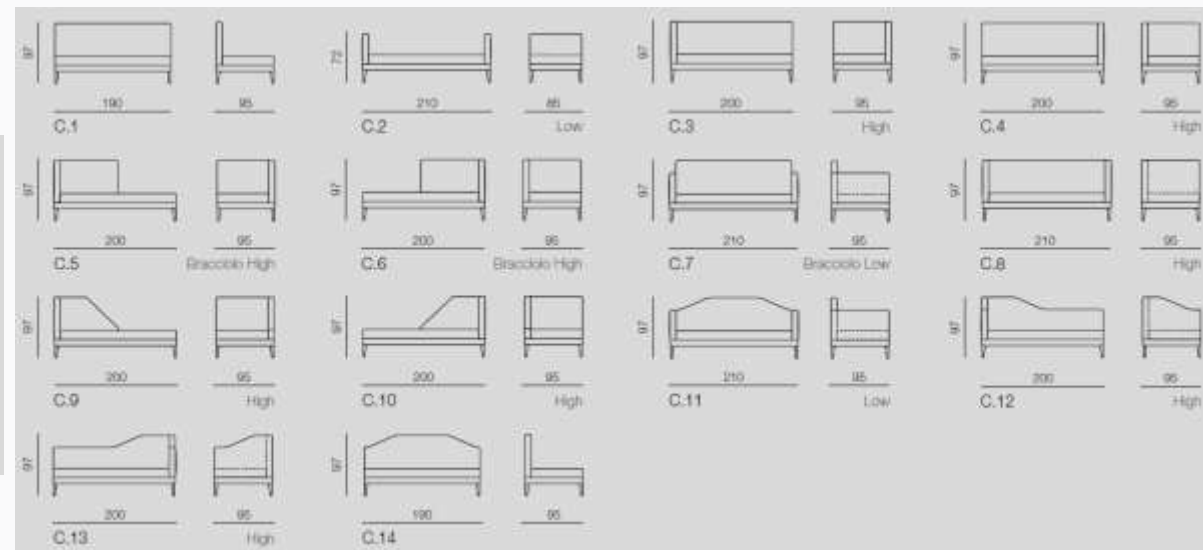

Score EcoVadis

68/100



- Tecido do cliente disponível
- Espuma retardante de fogo
- Tecido do cliente disponível
- Espuma retardante de fogo

- 160 revestimentos e cores disponíveis



- Sem correia
 - Sem espaço de armazenamento
- Sem cama pré-montada



CONTACT

FRANCE/EUROPE

Fabrice MORAND
f.morand@dorelanfrance.fr
 Tel: +33 7 72 36 58 84

ASTORE

*The 'overall' dimensions of Dorelan models are given for information only. A dimensional tolerance of 3 to 5% may be observed for all materials comprising textile and padded materials.

DORELAN, o principal fabricante italiano de roupa de cama e sofás conversíveis, foi fundado em Forlì em 1968

Dana UP model



PROPERTIES

- Density 45 Kg/M3
- Thickness 15 or 20 cm
- 24-month guarantee
- Easyflip® system: easy turning of the seat



DIMENSIONS



- From L200 x D93 cm
- Seat height: 45cm

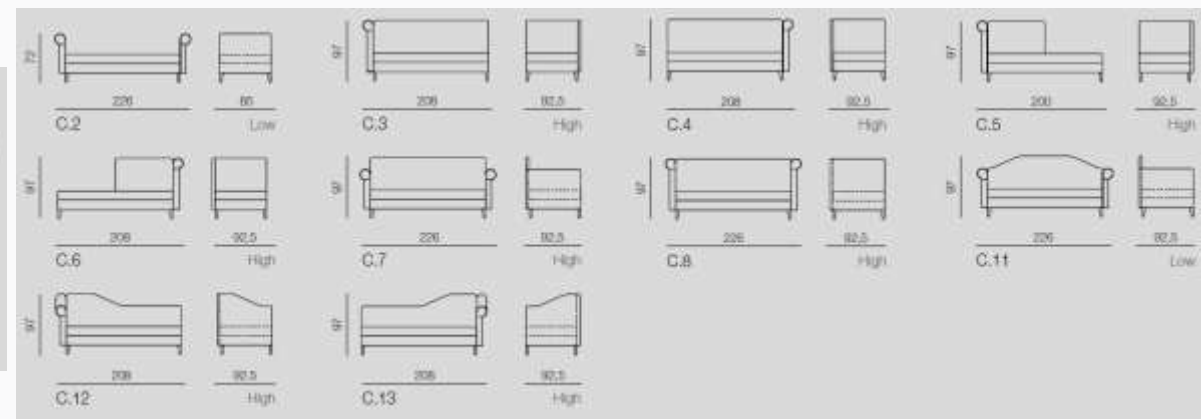

Score EcoVadis

68/100



*The 'overall' dimensions of Dorelan models are given for information only. A dimensional tolerance of 3 to 5% may be observed for all materials comprising textile and padded materials.



- Tecido do cliente disponível
- Espuma retardante de fogo
- Tecido do cliente disponível
- Espuma retardante de fogo
- 160 revestimentos e cores disponíveis



- Sem correia
- Sem espaço de armazenamento



CONTACT

FRANCE/EUROPE

Fabrice MORAND
f.morand@dorelanfrance.fr
 Tel: +33 7 72 36 58 84

ASTORE

Como o principal varejista online da Europa de móveis, iluminação e artigos para casa de design, a gama de produtos da Made In Design inclui marcas de topo (Kartell, Hay, Foscarini, etc.) e designers renomados (Starck, Dixon)

Model day Bed - CLASSICON



PROPERTIES

- Densidade: 35 kg/m³
- Garantia: 24 meses
- Despesas de envio e embalagem
- Espessura: 14 cm



DIMENSIONS

- L190 x P86
- Altura do assento: 38 cm



Score EcoVadis
52/100



- Tecido do cliente disponível
- Correia para o assento



- Sem espaço de armazenamento
- Sem cama pré-montada
- Sem capas removíveis



CONTACT

FRANCE/EUROPE

LASSALLE Charlène

charlene.lassalle@madeindesign.com

+33 (0)4.38.12.34.75

ASTORE

Fundada em 1982, a SOCA fabrica móveis de design contemporâneo sob medida para profissionais da hotelaria. A SOCA possui 3 áreas principais de especialização: criação de produtos de design e sob medida, estofamento e tapeçaria.

RENOVO MODEL



PROPERTIES

- Structure in wood and derivatives
- 100% cotton fitted sheet
- Polyurethane foam (50KG/m³)



DIMENSIONS

- Estrutura em madeira e derivados
- Lençol ajustável 100 % algodão
- Espuma de poliuretano (50 kg/m³)

Score EcoVadis
53/100



- Estrutura em madeira e derivados
- Lençol ajustável 100 % algodão
- Espuma de poliuretano (50 kg/m³)



- Sem espaço de armazenamento



CONTACT

FRANCE/EUROPE

Jacques de Mascureau
j.de.mascureau@soca.fr

Tel: + 33 2 40 68 85 10
ASTORE

CONVERTIBLE OTTOMANS



BK Group é uma empresa italiana que tem se especializado na produção de sofás e poltronas conversíveis há 60 anos

BK 116 model



PROPERTIES

- Espuma HR 40 kg/m³
- Garantia de 2 anos
- Custos de envio: a serem quantificados
- Espessura: 13 cm
- Estrado com ripas de madeira
- Colchão de molas (15 cm de altura)



DIMENSIONS

- L94 x P96 cm
- Altura do assento: 44/45 cm

Score EcoVadis
43/100



- Tela del cliente disponible
- Cama preinstalada
- Espuma ignífuga



Sem correia



CONTACT

FRANCE/EUROPE

Sara Mandelli
sara@bkitalia.com
Tel: + 39 03 63 48 971

ASTORE

DORELAN, o líder italiano no setor de roupa de cama e sofás-cama, foi fundado em Forlì em 1968.

GHOST model



PROPERTIES

- Thickness 10cm
- 24 Month guarantee



DIMENSIONS

- 75x 65x 50 cm
- Seat height: 37cm



- Tecido do cliente disponível
- Espuma retardante de fogo



- Sin correa
- Sin espacio de almacenamiento

Score EcoVadis
68/100



- Tecido do cliente disponível
- Espuma retardante de fogo

- 160 revestimentos e cores disponíveis



CONTACT

FRANCE/EUROPE

Fabrice MORAND
f.morand@dorelanfrance.fr
Tel: +33 7 72 36 58 84

Mousse du Nord Ottoman



HOME SPIRIT

FRANCE



Fabricante francês de sofás fixos e conversíveis, poltronas e cadeiras. Produção integrada (design - marcenaria - corte e estofamento de espuma - montagem de sofás).



PROPERTIES

- Sistema de abertura mecânico em ziguezague
- Espuma HR 35Klm3
- Espessura 10 cm
- Garantia de 5 anos



DIMENSIONS

- Dimensões totais: L83 x P75 cm
- Altura do assento: 47 cm

CASA model ottoman



Casa pouf / Footstool



- Possibilidade de utilizar tecido do cliente
- Capas removíveis



- Sem cama pré-instalada
- Sem assento com tiras
- Sem espaço de armazenamento

Score EcoVadis

49/100



Website:

www.homespirit.fr

- Disponível em tecido ou em couro sintético.
- Opção padrão M1 disponível.
- Mais de 250 cores e materiais.



CONTACT

FRANCE/EUROPE

Patric Lalarme
plalarme@homespirit.fr
Tel. 06 74 11 03 69



FITNESS & SPA EQUIPMENT

CODE

A C.O.D.E. ChillOut Design Evolution, com sede em França, é especializada na conceção e fabrico de camas de massagem de alta qualidade e mobiliário personalizado dedicado a ambientes profissionais e privados de bem-estar, relaxamento e beleza. O conceito C.O.D.E. oferece produtos únicos em termos de design personalizável, conforto superior e funcionalidade de alto desempenho.



Médio - Premium - Luxo - Estilo de vida

-10 a -15%
em camas



-20 a 30%
em opções

5 anos de garantia nos motores

Presença nos conceitos ACCOR

Orient Express La Minerva, Roma (Itália)

MGallery Domaine de la Reine Margot, Issy-les-Moulineaux (França)

Mama Shelter Dubai (EAU)

Mondrian Les Carmes, Bordéus (França)

RSE

Materiais reciclados ✓

Programa de segunda vida ✓

Conceção ecológica ✓

Serviços

Personalizados ✗

Personalização do produto ✓

Produção: Itália

 <https://www.code-spa.design/en/>

Contacto:

Angelica MARAN
am@code-spa.design
+(39) 3480466508



CODE
CHILL OUT DESIGN EVOLUTION
Luxury spa furniture

ASTORE

Gharieni

30 anos de inovação e engenharia alemã são os pilares da marca global premium do Grupo Gharieni, conhecida pelas suas tecnologias de bem-estar comprovadas para a mente e o corpo e pelos equipamentos médicos, de spa e de bem-estar da mais alta qualidade.

-20 a 30% sobre os preços públicos

Garantia:



- **10 anos para** peças metálicas e estruturas
- **5 anos para** motores
- **3 anos para** outras peças

Presença nos conceitos ACCOR

Faimont Montreux Palace (Suíça)
Sofitel Frankfurt Opera (Alemanha)
Sofitel Dubai The Obelisk (Emirados Árabes Unidos)
Hotel Molitor – MGallery Collection, Paris (França)



Premium – Luxo – Estilo de vida

RSE

Materiais reciclados ✓

Programa de segunda vida ✓

Conceção ecológica ✓

Serviços

Feito à medida ✗

Personalização do produto ✓

Produção: Alemanha

Certificações:
ISO 13485

 <https://www.gharieni.com/>

**Pontuação
EcoVadis**



Contacto:

Aurore HADDOU
a.haddou@gharieni.com
+33 6 42 14 79 95



GHARIENI

ASTORE

Lemi

Era o início da década de 1990 e novos conceitos de bem-estar estavam a ser combinados com um espírito de criatividade, iniciativa e paixão pelo design, transformando assim o sonho numa empresa de grande alcance. A empresa é reconhecida pelo seu design excecional, investigação, tecnologia, qualidade, funcionalidade e acabamentos meticulosos.



-30% sobre os preços públicos

Até 10 anos de garantia
e assistência **vitalícia**

RSE

Materiais reciclados ✓

Programa de segunda vida ✓

Conceção ecológica ✓

Serviços

Feito à medida ✗

Personalização do produto ✓

Produção: Itália

Certificações



 <https://www.lemispa.com/en/>

Contacto:

Elena Bazzocchi
elena.bazzocchi@lemigroup.it
+39 335 7742393

Presença nos conceitos ACCOR

Faimont Windsor Park, Englefield Green (Reino Unido)
SO/ Sotogrande (Espanha)



Premium – Luxo – Estilo de vida

Lemi
ITALIAN WELLNESS EQUIPMENT™

ASTORE

Life Fitness

«A Life Fitness compreende as necessidades tanto dos hotéis independentes como das cadeias internacionais.
Ajudam a definir os padrões da marca das instalações de fitness, a diferenciá-lo da concorrência e a aumentar a satisfação do cliente ao longo do processo.»



Cerca de **-50%** sobre os preços públicos (Preços EXW)

Garantia de 2 anos para todos os produtos

Garantia de 10 anos para a estrutura de todos os produtos de resistência fabricados

Recomendação por gama de hotéis:



Activate cardio, Axiom Resistance & Racks



Integrity cardio, Insignia Resistance & Racks



Elevation – Discover cardio, Synergy Resistance & Hammer Strength

Serviços

Experiência virtual, nuvem, treinador digital, ecrã HD...

Especialista em design de instalação

Produção: Europa, Ásia

Pontuação EcoVadis
39/100

Contacto:

Richard Burden
Richard.Burden@lifefitness.com



<https://www.lifefitnessemea.com/en-eu>



Gama Económica – Média – Premium



 **LIFEFITNESS**
FAMILY OF BRANDS

ASTORE

Matrix

“A Matrix entende que o fitness faz parte de uma ideia cada vez mais holística de bem-estar que influencia todo o tipo de decisões relacionadas ao estilo de vida, incluindo onde ficar durante uma viagem. O fitness tornou-se uma expectativa; a Matrix pode ajudá-lo a transformá-lo numa experiência!”

 Gama Eco - Média – Premium – Luxo - Estilo de vida

Cerca de -40%
Sobre os preços públicos (Preços FOB)
3 anos
Garantia de peças e mão de obra



Recomendação por gama de hotéis:



Série Lifestyle cardio com série Go strength ou série Versa strength



Série cardio de resistência com série de força Versa plus



Série cardio Performance com série Ultra Strength e consolas de treino inteligentes

Serviços

Feito sob medida X

Personalização do produto X

Produção: Europa, Ásia

Pontuação EcoVadis
39/100

Contacto:

Gary YOUNG
gary.young@jhtgroup.uk
+44 (0) 7974 115 897



<https://www.matrixfitness.com/en>

MATRIX
Strong • Smart • Beautiful

ASTORE

PBI - Probeautic Institut

O PBI - Probeautic Institut é um especialista reconhecido em produtos de beleza profissionais desde a sua criação em 1997. Como fabricante e grossista especializado em equipamentos para profissionais de beleza, com mais de 6000 referências, oferecemos uma vasta gama de produtos e marcas profissionais para venda.



Médio segmento - Premium - Luxo - Estilo de vida

-10% sobre os preços de catálogo
Condições especiais para projetos de construção ou renovação.

Garantia **de 1 a 2 anos**

Presença nos conceitos ACCOR
MGallery Les Cures Marines, Trouville (França)
MGallery Cabot, Bordéus (França)
Novotel Avignon Centre (França)

RSE

- Material reciclado ✓
- Programa de segunda vida ✓
- Conceção ecológica ✓

Serviços

- Personalizados ✗
- Personalização do produto ✗



EQUIPAMENTO DE SPA



EQUIPAMENTO DE MANICURE E PEDICURE



AMBIENTE E DECORAÇÃO DE SPA



BOUTIQUE DE VENDAS A RETALHO DO SPA



WELL TECH



MASSAGEM E CUIDADOS COM A PELE



ROUPA DE CAMA DESCARTÁVEL E VESTUÁRIO



ROUPA DE SPA, LENÇÓIS, COBERTORES E UNIFORMES



HIGIENIZAÇÃO E LIMPEZA



DEPILAÇÃO

Âmbito de distribuição:

França e Dom-Tom, Mónaco, Andorra, Suíça, Europa, Médio Oriente, Norte de África

Certificações:

- Membro da SPA-A
- Classificação Ethifinance
- Patrocinador Pure Océan
- Membro Citeo
- Membro da ÉcoSystem

Contacto:

Mohamed ARAII
mohamed.araii@pbifrance.com
+33 (0) 634 240 722



<https://www.probeauticinstitut.com/>

pbi
probeautic institut

ESTHÉTIQUE | SPA | WELLNESS

ASTORE

Precor

Equipe o seu ginásio com soluções de fitness preferidas e confiáveis por praticantes, treinadores e operadores de instalações em mais de 100 países.

45% Percentagem de desconto sobre o preço de retalho

2 anos, 10 anos de garantia **para as armações**

RSE

Materiais reciclados ✓

Programa de segunda vida ✗

Conceção ecológica ✗

Serviços

Personalizados ✗

Personalização do produto ✗

Produção: Europa, Ásia

Pontuação EcoVadis

58/100



Contacto:

Nikki Doolan
Nikki.doolan@precor.com
+44 (0) 744 308 30 62



<https://www.precor.com/>



Gama Eco - Média gama - Premium



PRECOR

ASTORE

Technogym

«A oferta principal da empresa é o Technogym Ecosystem, composto por equipamentos inteligentes para treino cardiovascular, treino de força e treino funcional, juntamente com a plataforma de rede mais avançada e uma gama completa de serviços.»

-10% a -35%

Sobre os preços públicos (preços EXW)
Garantia de **2 anos** (peças sobressalentes) e **1 ano** (mão de obra)

Recomendação por gama de hotéis:



Cardio, Excite Live 500 700 900 /
Força, Selection 700



Cardio, Excite Live 5000 7000
9000 / Força, Selection 900



Cardio e Força, Artis Line

Produção: Europa, Itália, Ásia



Contacto:

Camilla Menegazzo -
cmenegazzo@technogym.com

Serviços

Serviços de design de
interiores da Technogym

Solução de bem-estar total:
equipamentos inteligentes
conectados, soluções digitais,
programas e educação,
serviços financeiros...

Certificações

142 patentes internacionais
e mais de 93 marcas
registadas

**Pontuação
EcoVadis**

84/100



<https://www.technogym.com/>



Gama Média – Premium – Luxo – Estilo de vida



TECHNOGYM

ASTORE

ASTORE

YOUR PROCUREMENT PARTNER

ASTORE